

ALTERNATIVES

CULTURE BREAKERS

& OTHER NUMBERS

TH
6021
.18x

MSS

KEN ISAACS

This is the context of our time and the field for all action.

Man is an animal. Despite the exquisite development of his higher brain centers and the opposable thumb, his central interest and focus must be survival. The word survival has become inflexibly linked to the idea of existence on a subsistence level. This term must be broadened to describe a total favorable continuum. The neurotically unhappy man is not surviving, no matter what is (or is not) on his menu for dinner.

The comprehensive view shows man, the superior animal, utilizing the tool function of the mind to construct from sense experience relationships involving previously uncommitted entities in order to promote growth for the purpose of survival.

Design must be an intensified version of the previous schema drawing upon experience and observation, personal and extrapersonal, to construct relationships directed not toward beauty, but toward obtaining survival in the full sense for the greatest possible number of men.

The possibilities for the expression of conflict allowed by the technical developments of the last 500 years have no ceiling. Massive contradictions have developed with the precarious logic which marks the psychotic individual and the inharmonious society.

One of the most currently hopeful and interesting human attitudes, the body of behavior we call science, has become so abstracted and removed from any meaningful association with life that its main use is as court wizard to government and industry.

A culture which could nurture such contradictions deserves subjectation to the closest scrutiny so that only those elements which contribute to evolutionary change may be retained and used as parts of a new formation.

MICROSE HOUSSE

Although the advantages which follow reduction in the size of dwellings are very real, traditional fixations favoring separate pieces of furniture have given unsatisfactory results when overall cubage of the house is reduced.

It's not what you have, it's what you do with it.

Generally speaking, both traditional and contemporary design have been satisfied to deal with the interior fittings of buildings as a kind of afterthought seeking only visual consistency without deep concern for functional possibilities.

The MICROHOUSE idea is a total approach to the shelter problem which considers the entire unit as an armature or MATRIX for all human activities possible in relation to the structure. The result is an environment with components fully integrated because their form is determined by the relationships at issue.

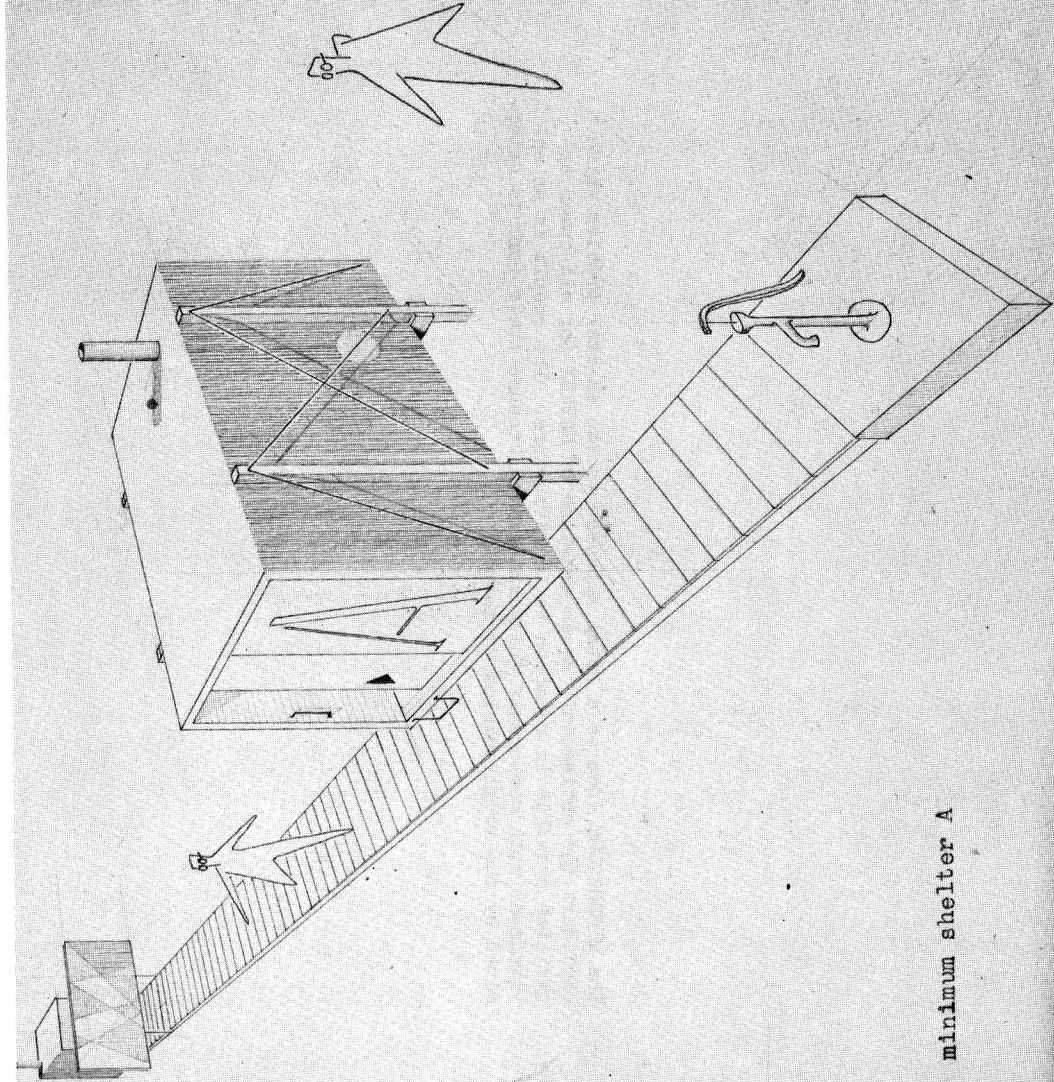

minimum shelter A

This unit, in addition to using the most simple plumbing and sanitation facilities, integrates the necessary components usually associated with conventional homes.

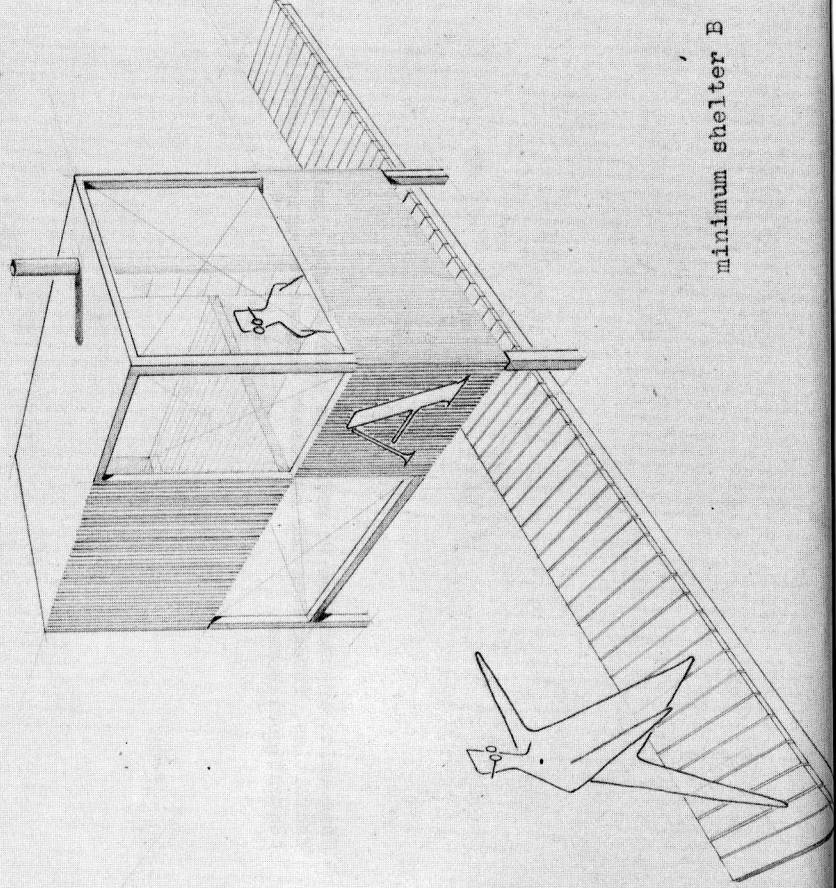

minimum shelter B

Cooking and entry on base level where interior figure stands/ reading,
work and study on elevated platform behind/ sleeping beneath behind
long glass area.

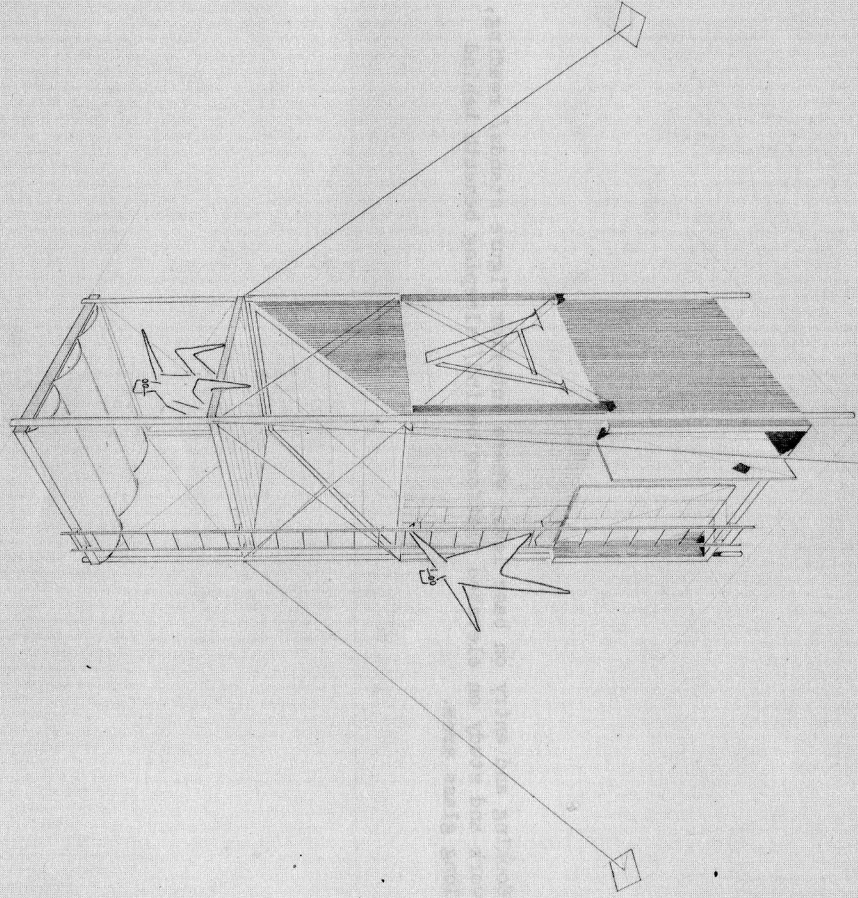

The 'tall house' utilizes the third dimension even more completely than the previous houses with cooking on the bottom, study-work on the middle level and sleeping net just under the skylite. Topside outside is a sun-deck.

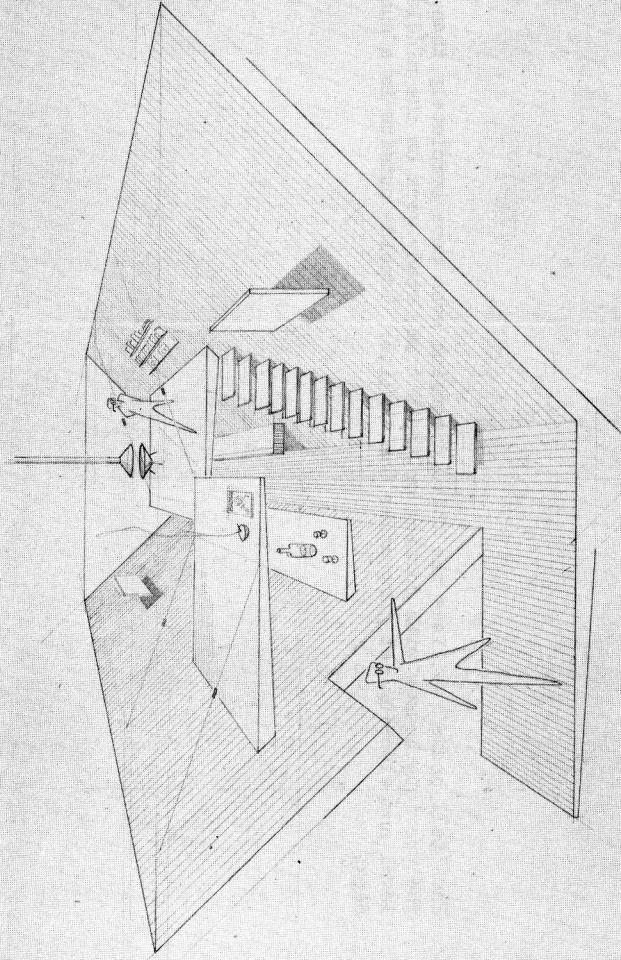

The 'V-house' (1950) is a variation on the multi-level concept with cooking and equipment concentrated in the base.

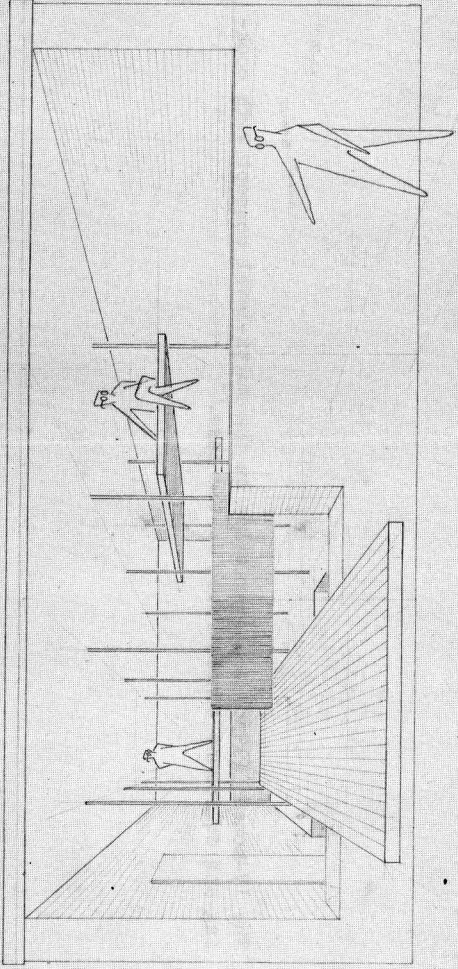

With the development of the '#1 house' the idea of a regularized NETWORK to support the multilevels appeared.

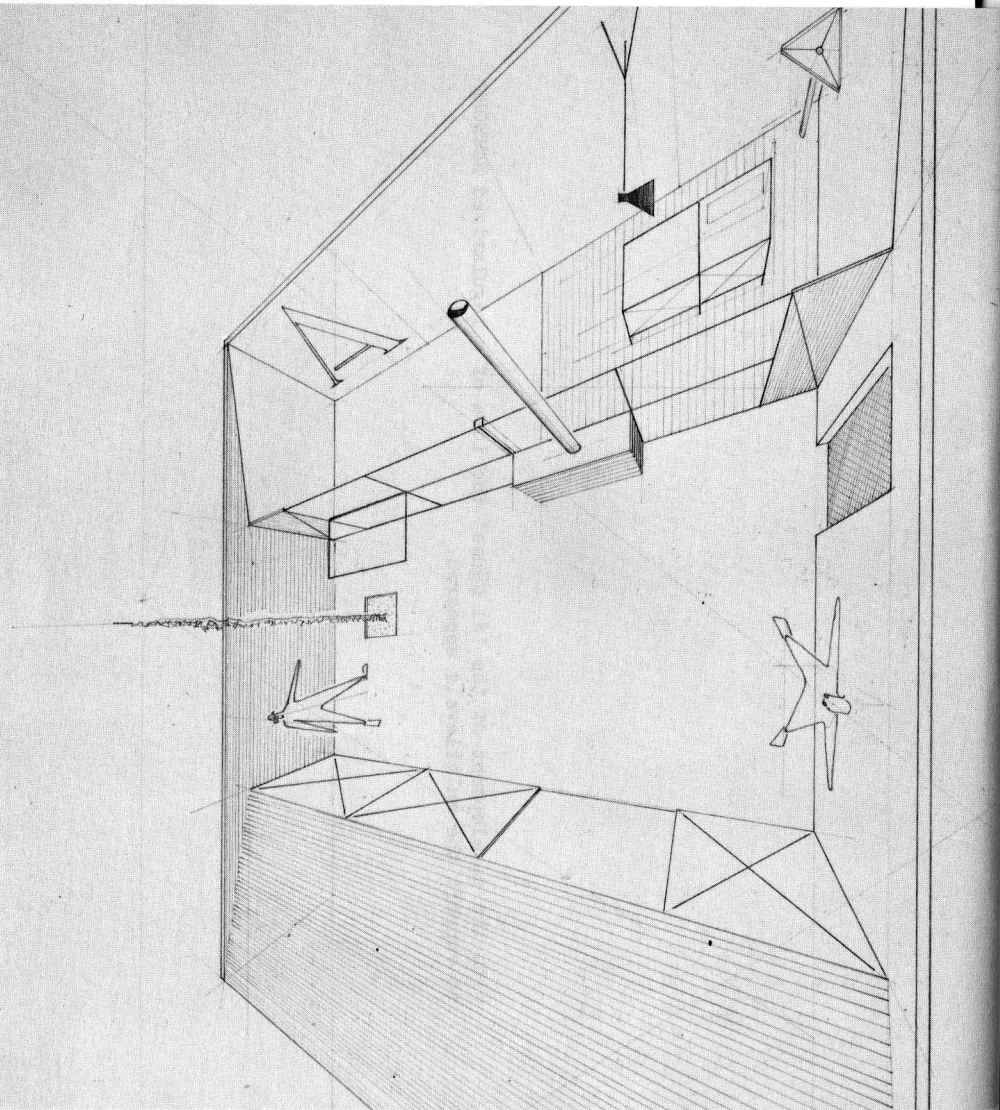

2 identical units opposite each other
creating outdoor use space
sun-trap in winter
eat in one unit
sleep in other
work in both
infinitely small space
utilize the advantages of the court area

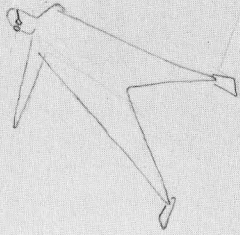
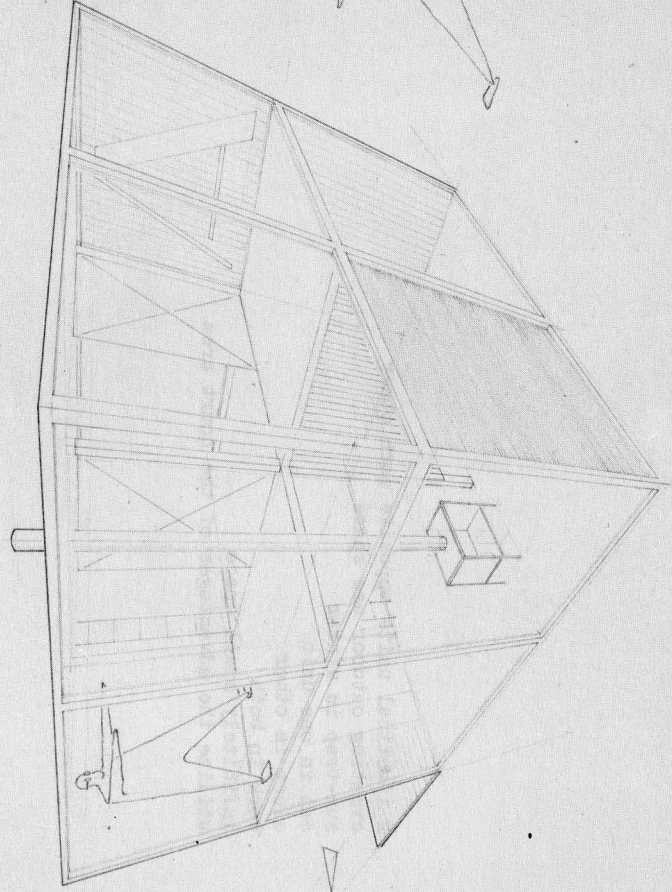

4" box beams flushwelded and ground
fill frames with various panels
sleep and lounge on upper levels
cube approximately 12' on a side
so 12' ceiling is half of the space
sleeping space for guests
back to back plumbing package...

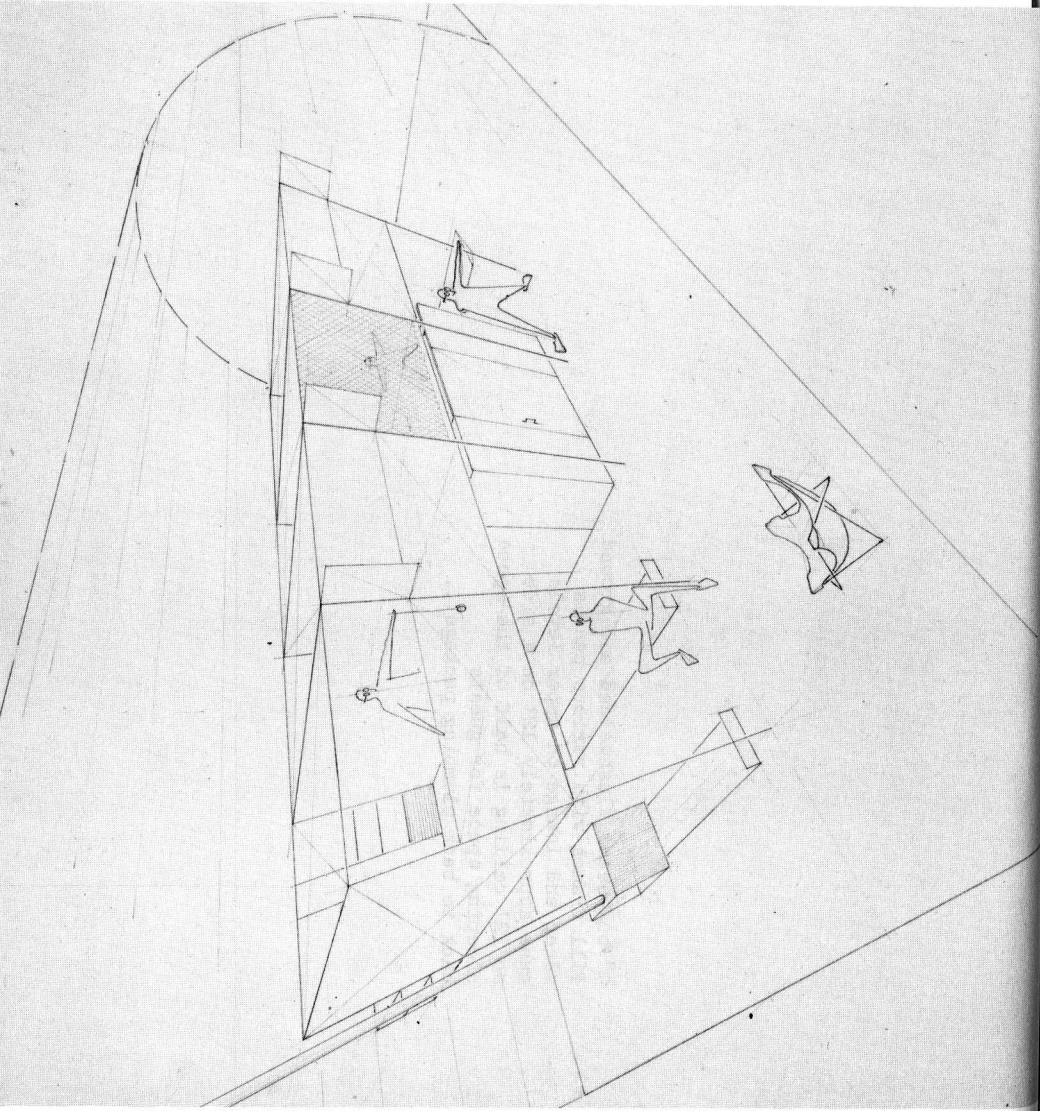

This house is one of the earliest embodying the principle of separation of weatherproofing from interior structure. The sheltering vault may be concrete or plastic. This idea makes possible an entirely new freedom and clarity in the house.

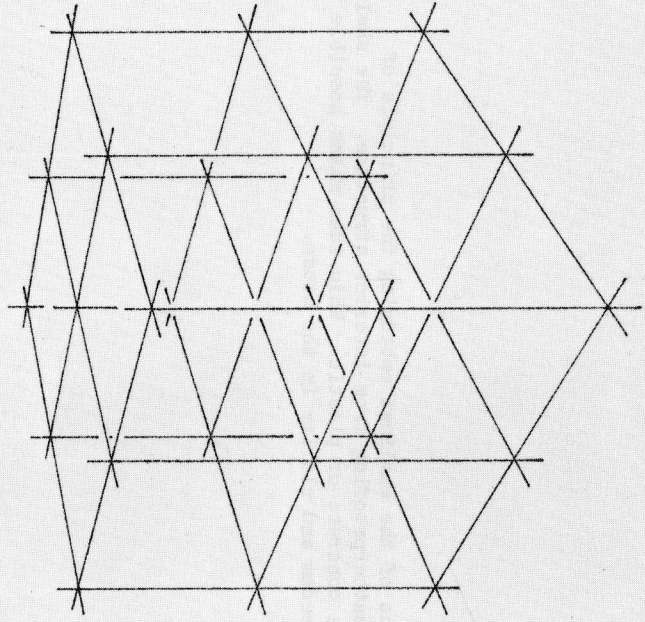

This diagram shows the fully regularized MATRIX NETWORK which grew out of the earlier housing experiments.

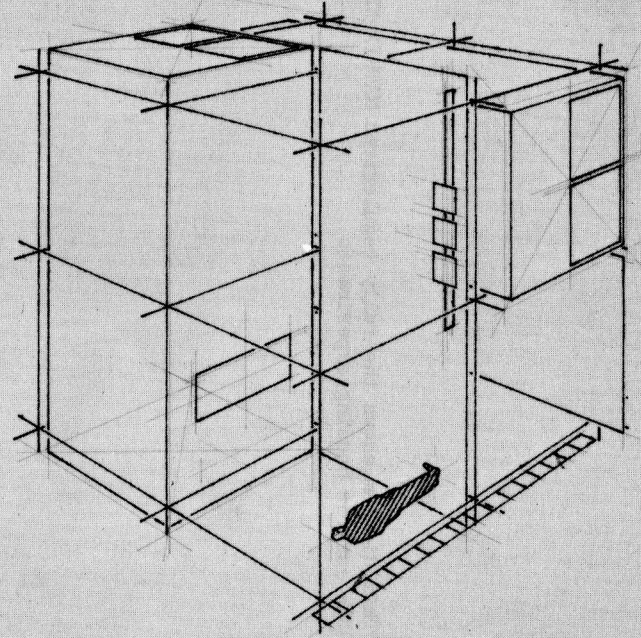

One of the possible ways of integrating shelter components into the MATRIX NETWORK is illustrated in this MICROHOUSE.



The Matrix Research Project near Groveland, Illinois, funded by the Graham Foundation for Advanced Research was the actualization of the concept of the MICROHOUSE.

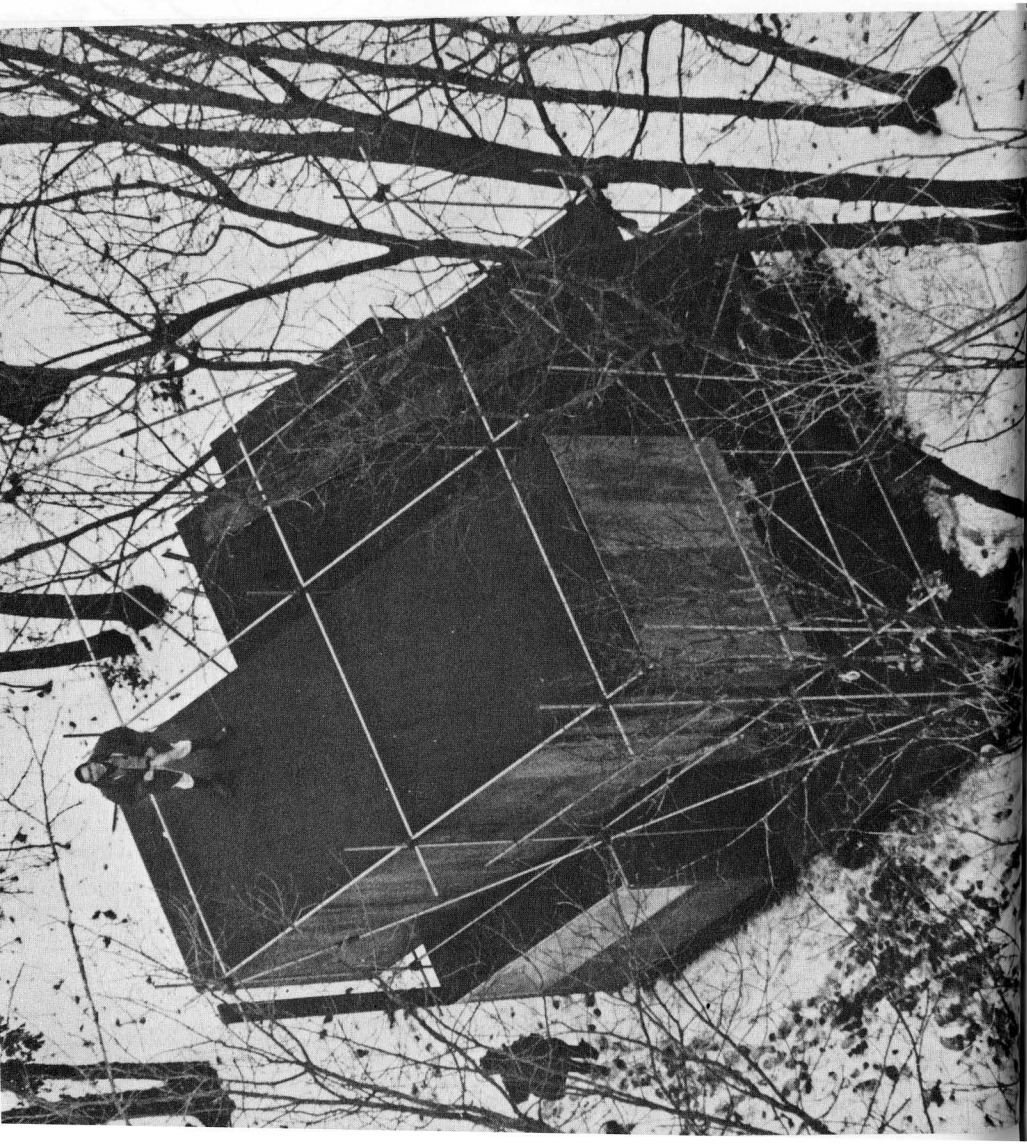

The MICROHOUSE was set in a clearing and one of the fundamental objectives was the least alteration of the natural balance of the environment.

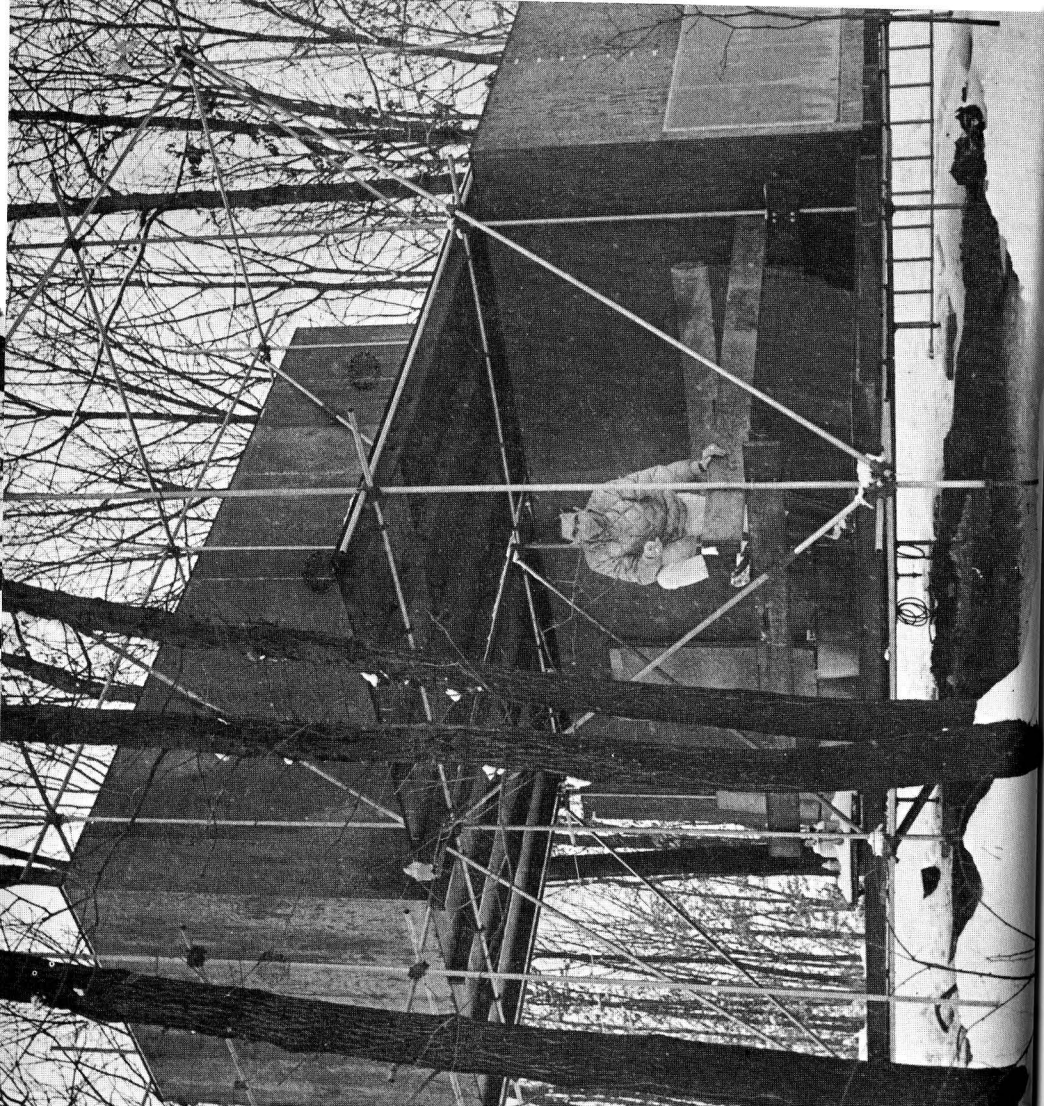

Despite the fragile appearance, the NETWORK is sturdy having survived winds of 80 mph. The closed volumes are insulated and comfortable in temperatures of -20 degrees F.

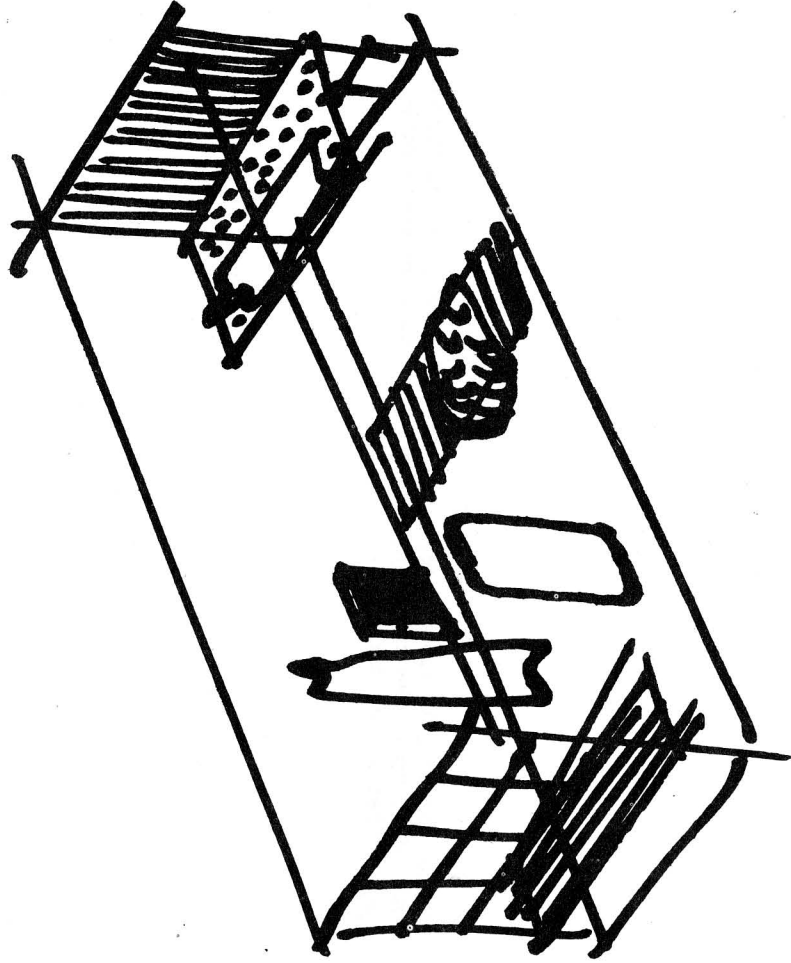
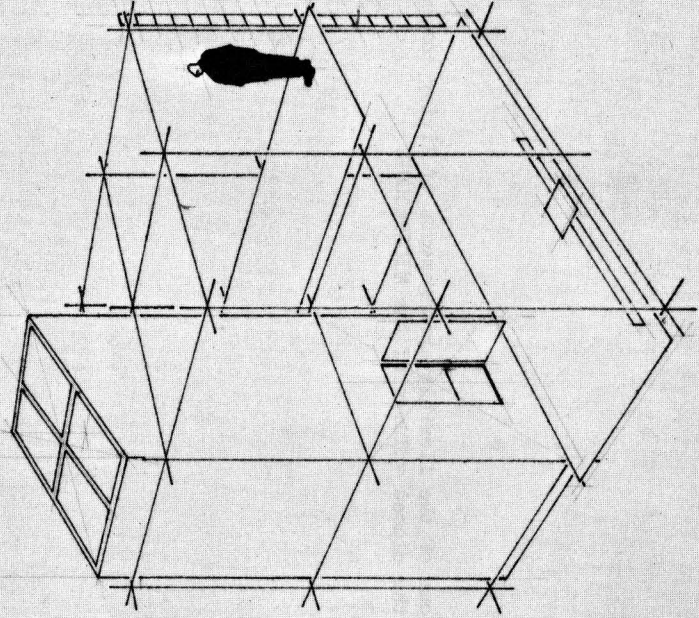
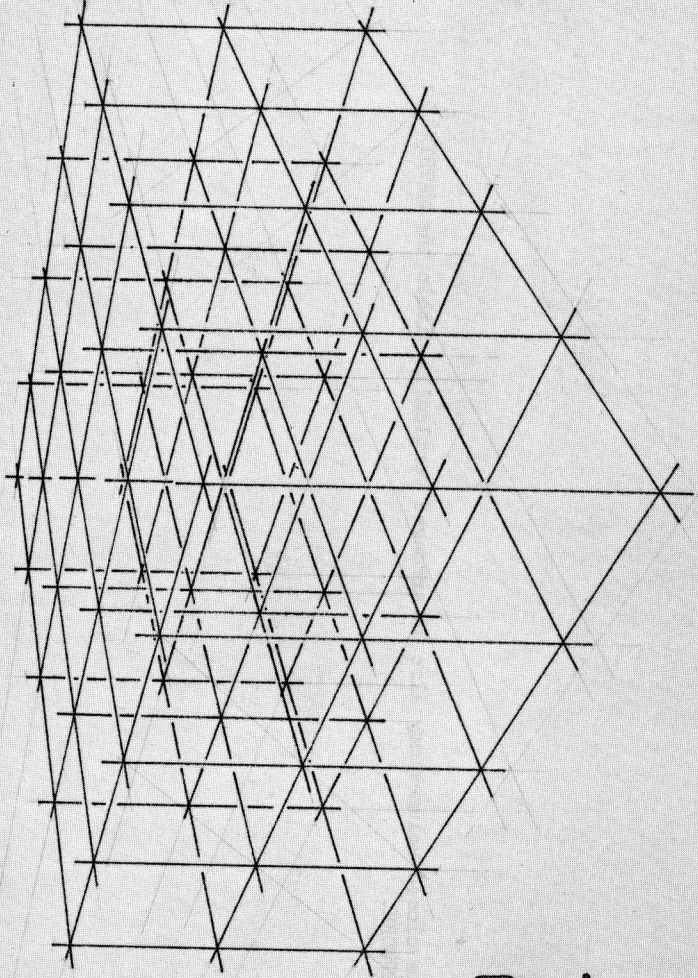

Illustration of one of the flexible arrangements of living components possible within the closed volumes of the MICROHOUSE.



The closed volumes may also be arranged vertically within the MATRIX NETWORK.



The MATRIX NETWORK can be extended and a variety of volumes may be included.

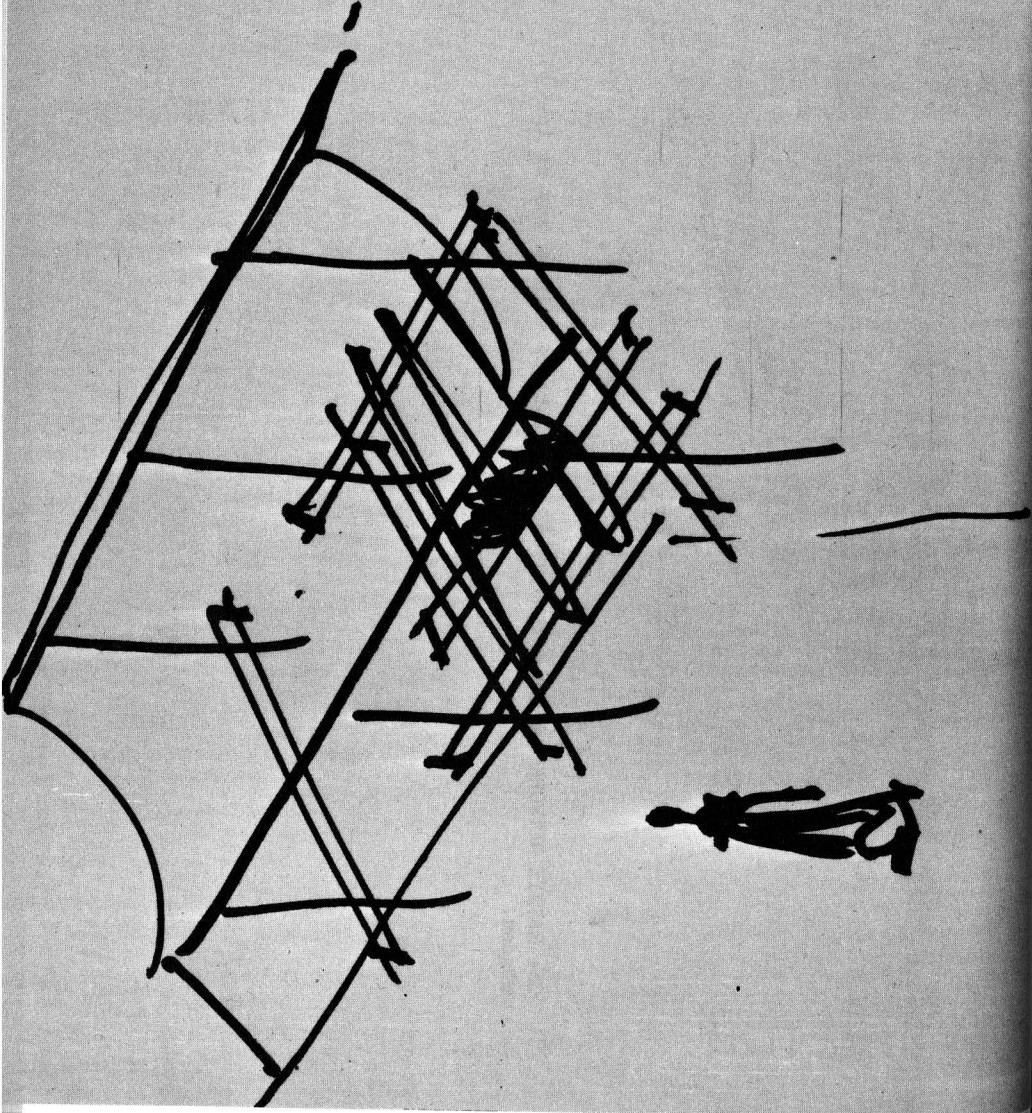

Early sketch of possible tooling facility used in the Matrix Research Project near Groveland, Illinois.



Actualization of tooling facility using trees cut on the site.



MICROHOUSES require no conventional foundation which is in keeping with their tradition-breaking form. They are set on pads or feet which are at grade level.

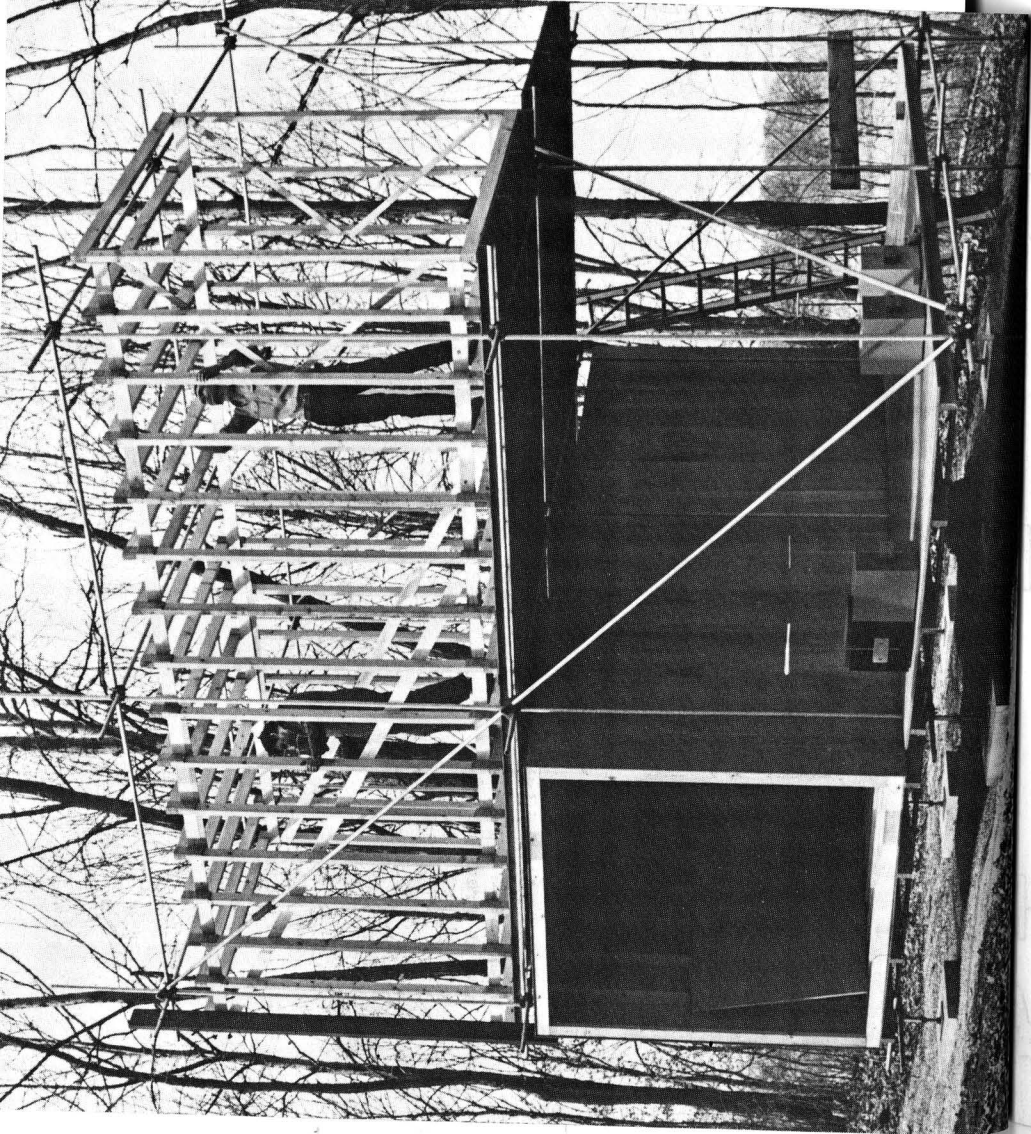

The prototype MICROHOUSE at Groveland under construction. Later versions are completely panelized in plastic or plywood.

'FUN HOUSE' IS REALLY THE
LIVING STRUCTURE 10.3 X 10.3
BUT BY ANY NAME IT'S A NEW
KIND OF BASE CAMP FOR THE
EXPLORATION OF THE WORLD.

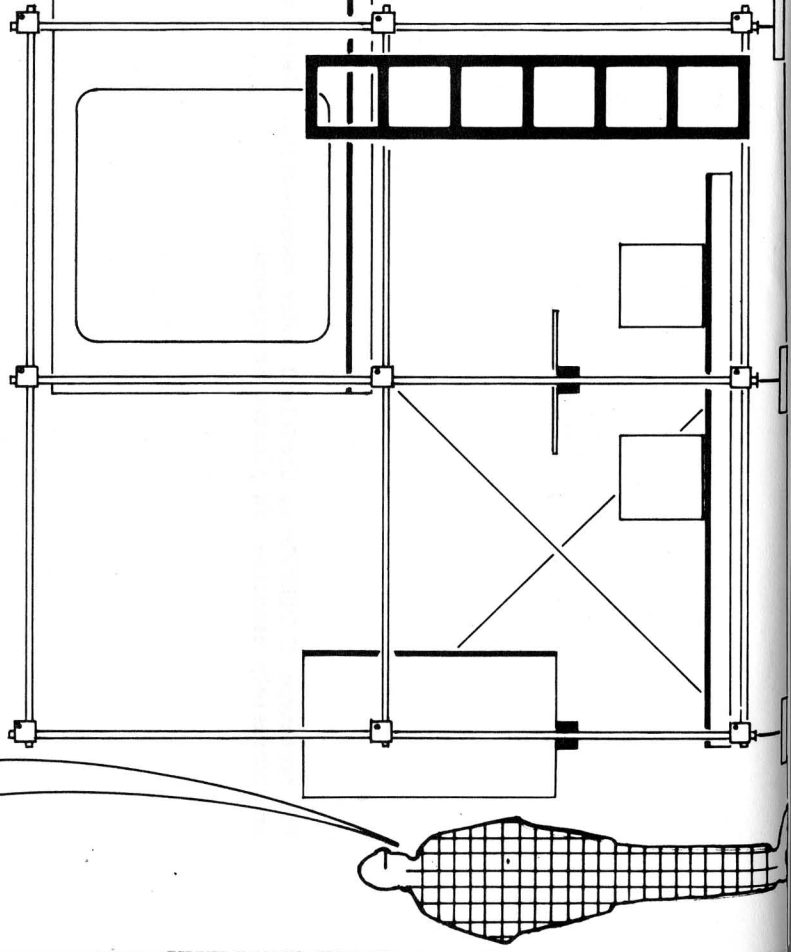

A MICROHOUSE is adaptable to any natural environment.

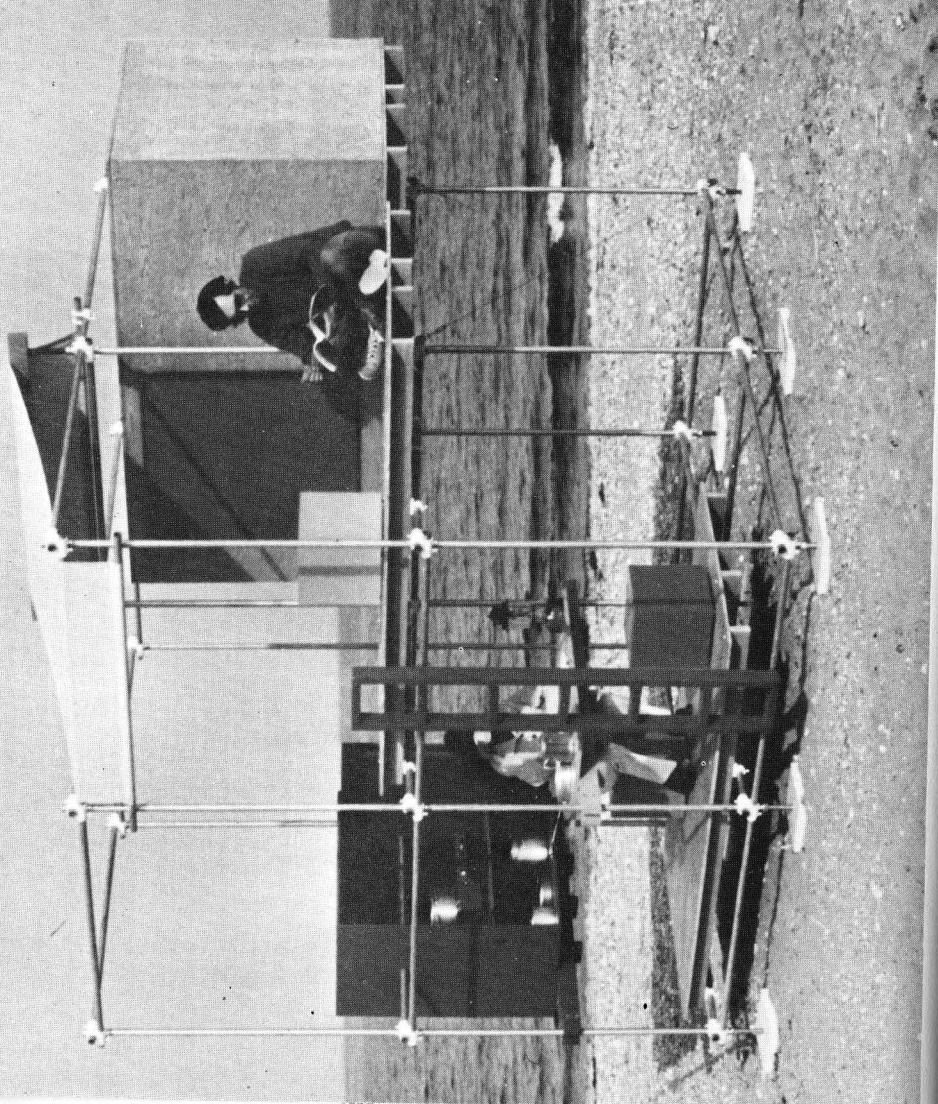

This beach structure has a minimum of enclosed space. Its openness is well-suited to its location.

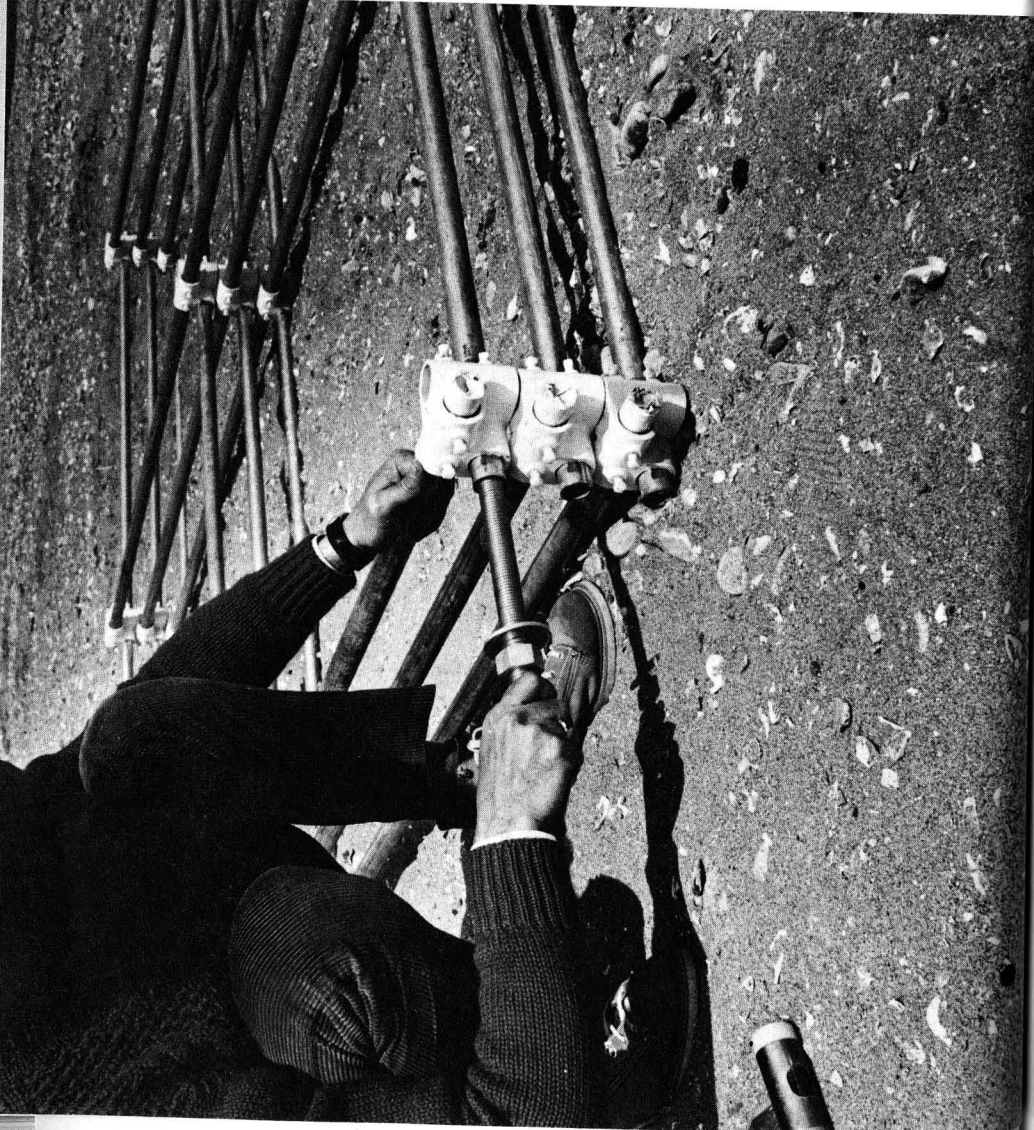

The basis of the MATRIX NETWORK is assembled flat on the ground.

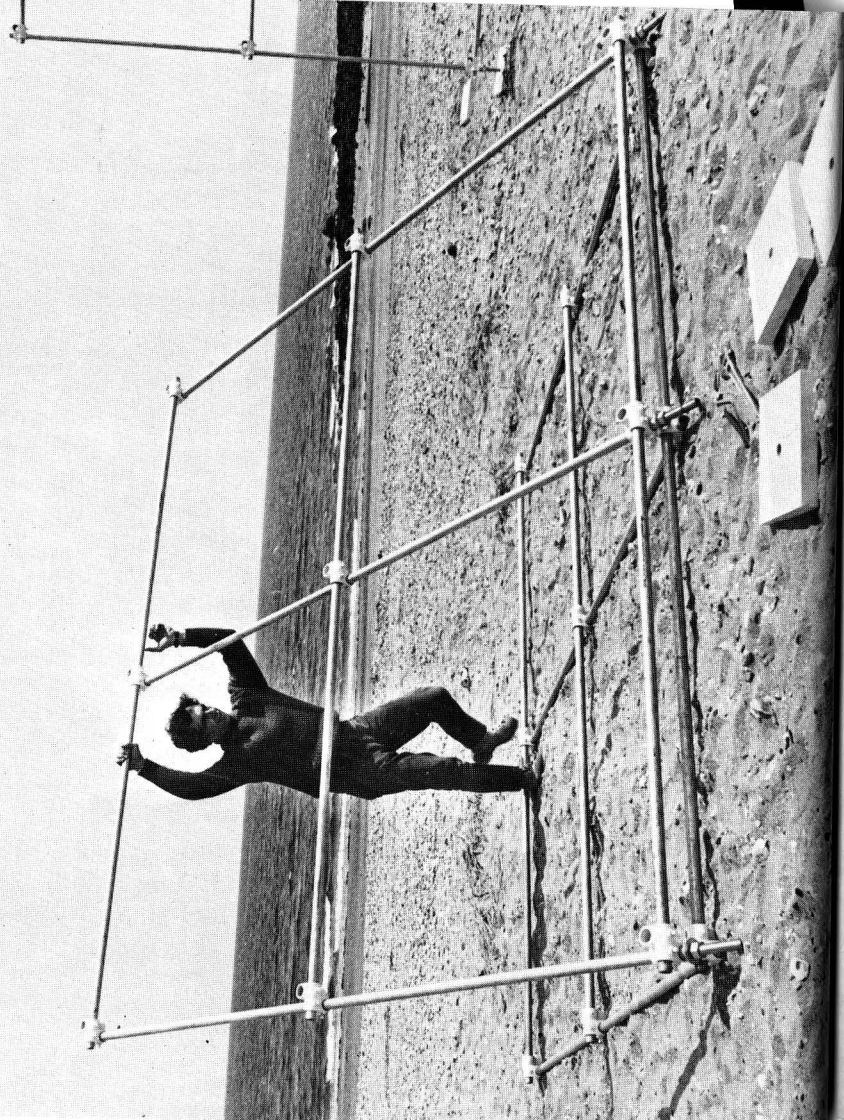

Actualizing the MATRIX NETWORK. One of the values intrinsic to this type of structure is the ease with which it can be assembled or broken down for relocation.

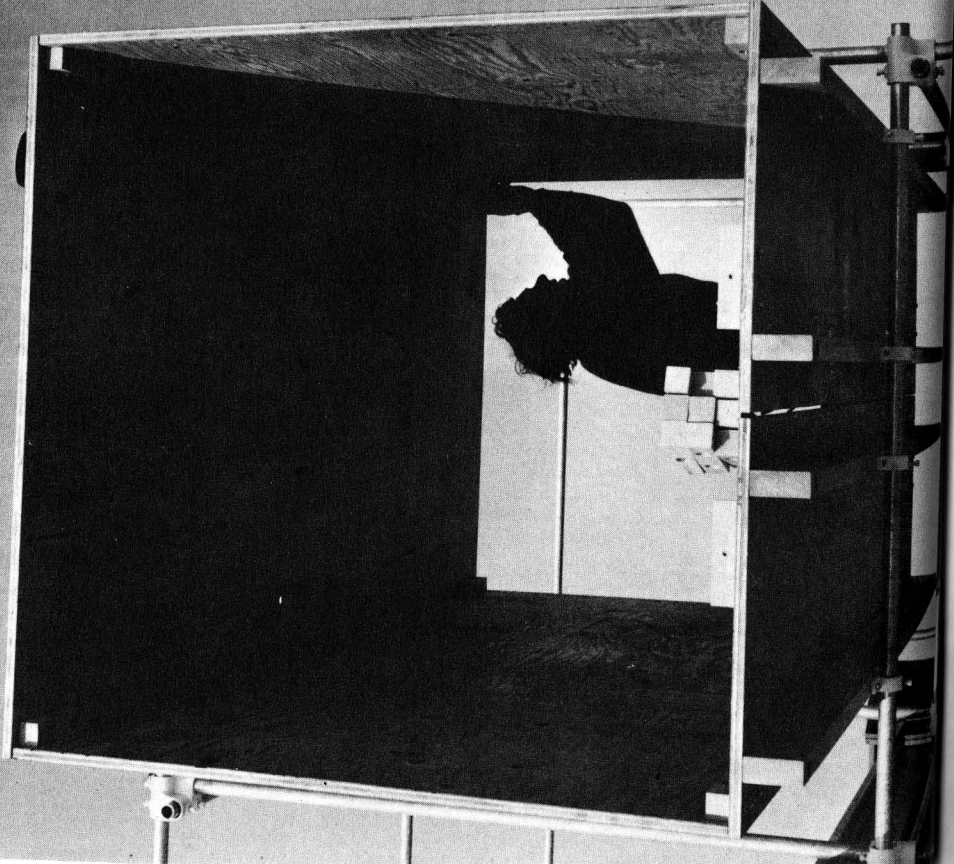

Enclosing the sleeping volume.



The cooking platform is located on the lower level.

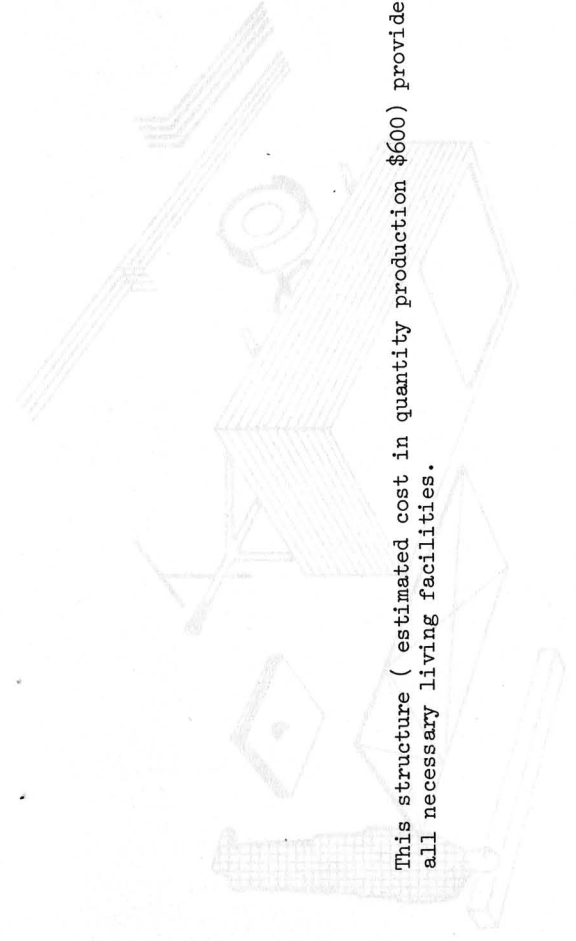
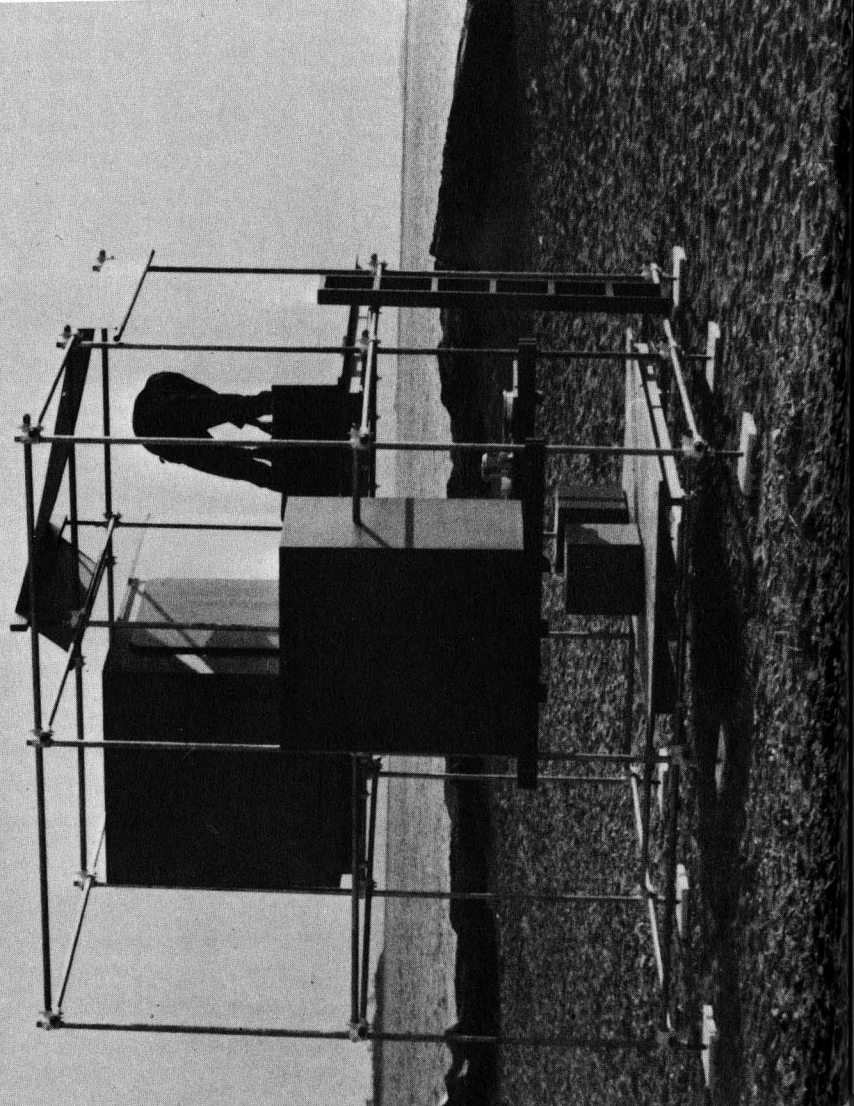

This structure (estimated cost in quantity production \$600) provides all necessary living facilities.

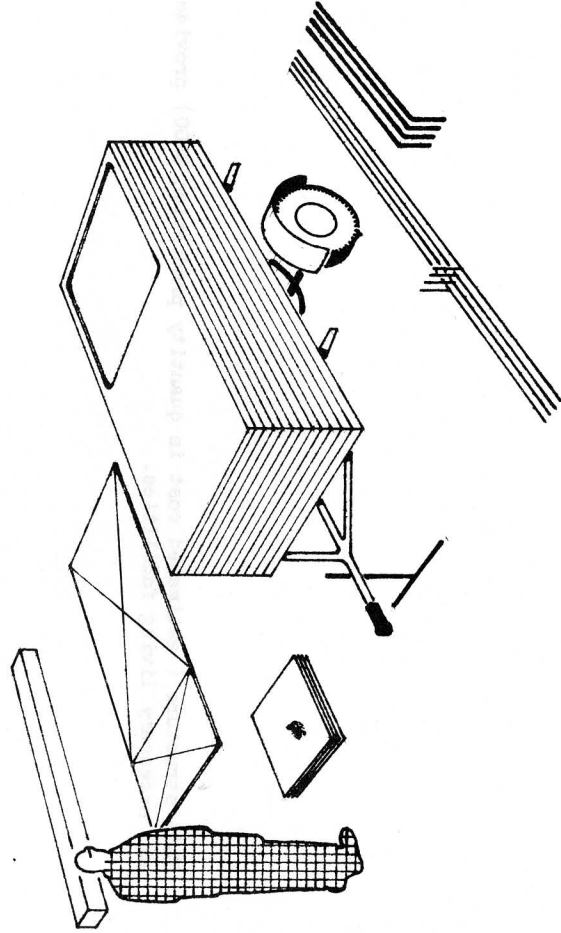

The components for MICROHOUSE 8 x 8 can be transported on a boat trailer.

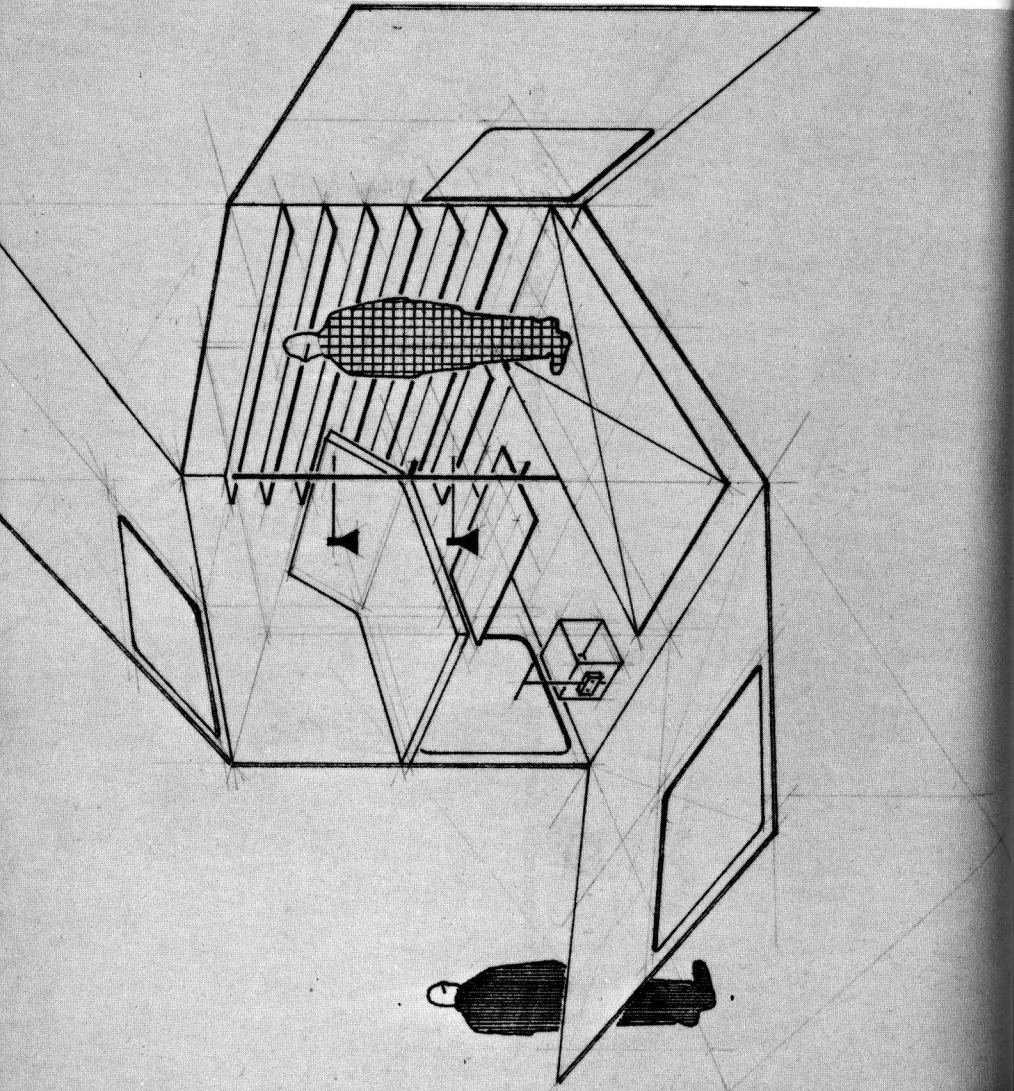

The MICROHOUSE 8 x 8 has an elevated sleeping surface with skylite over it and sitting-eating area beneath. Hygiene and bathing facilities are under the raised floor with cooking and storage shelves on the back wall.

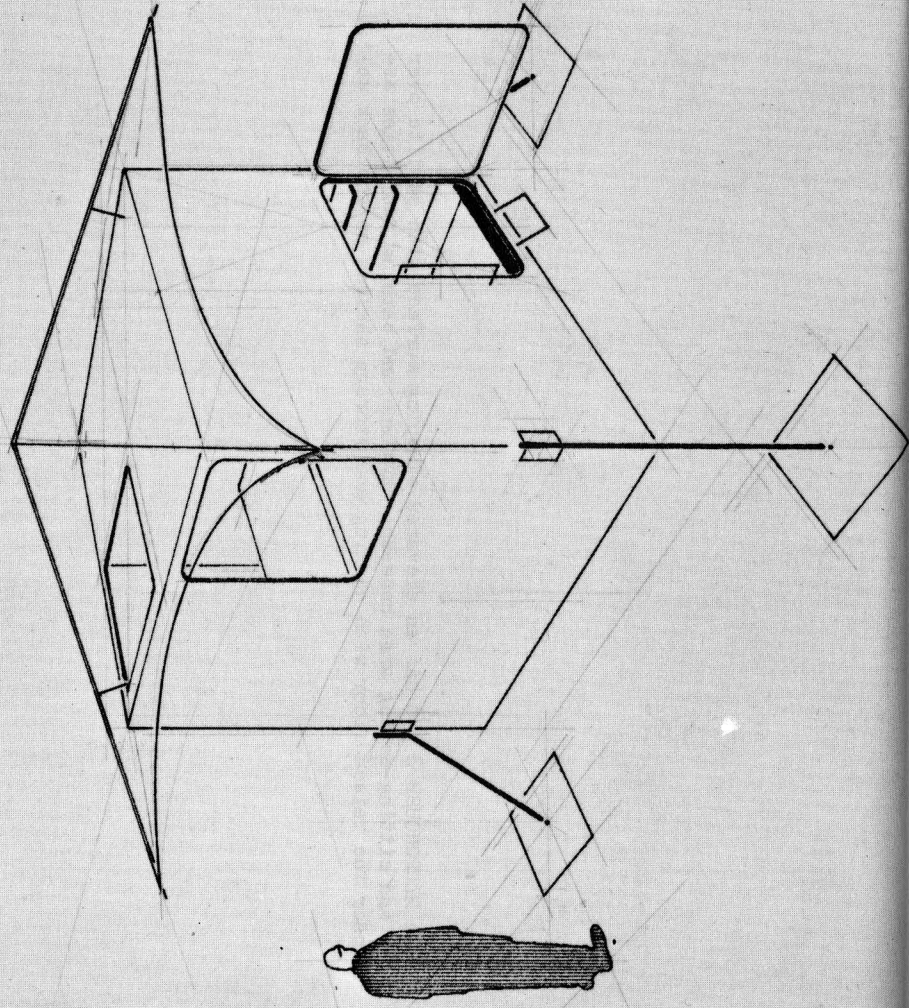

Weather protection is by the mylar parasol with entry port on the right.

Each cube could be used by one person long-term or two persons short-term.

A group of cubes would form the new world village complex.

LIVING STRUCTURES

These units fulfill the functions traditionally assigned to individual physically unrelated pieces of furniture. They are total environments for living.

Usage areas are related in a systemic way interpenetrating each other and all integrated into a compact mobile physical nucleus. This concentration of physical equipment creates uncommitted space in the smallest rooms.

Simple to clean and maintain the units advance individual freedom of action by eliminating the need for domestic help or specialists of any kind. The configuration is so simple and the principles so susceptible to variation that no great barriers exist to the fabrication of the units by the user.

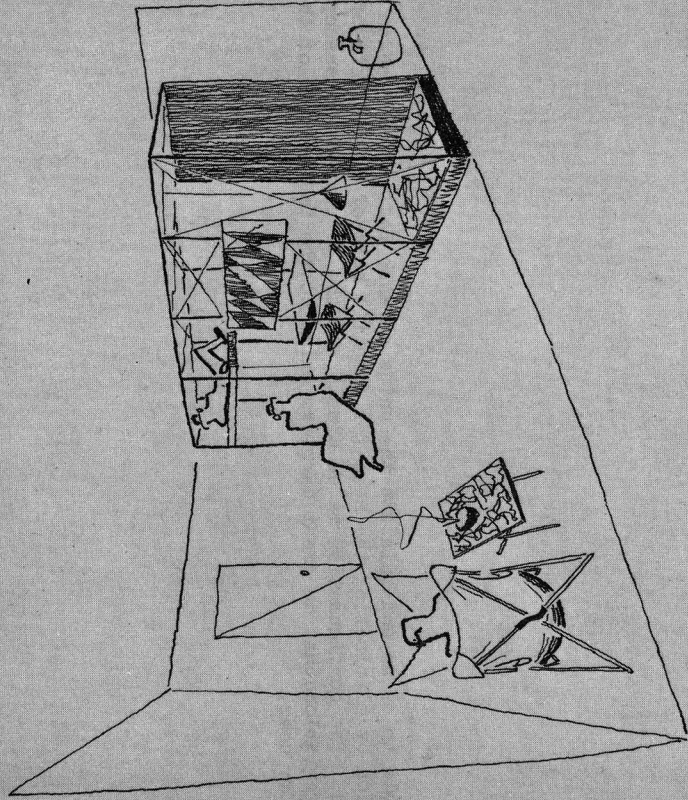

This is a drawing of the first aggregated furniture unit.

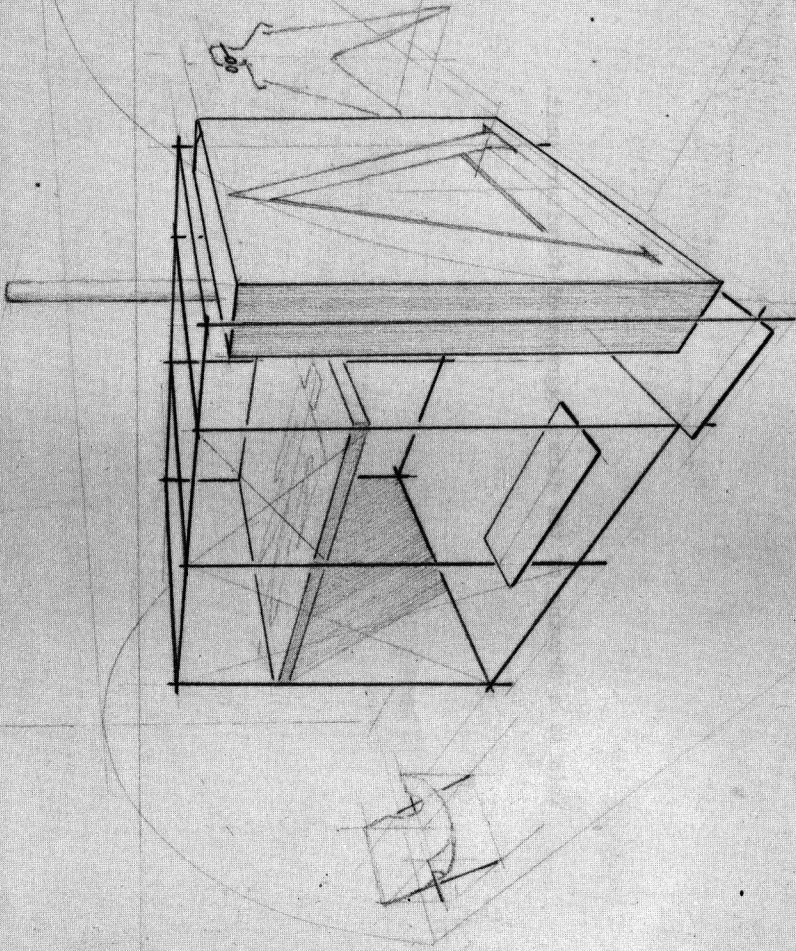

to gain that goal of conceptual and actual cleanliness....
to reclaim space frequently pre-empted by the bed....
to give young free people conceptual and actual oneness of
surroundings....
to build a strong universal structure upon which individuals
may base individual arrangement.....

for these reasons and others, this spaceframe was designed.

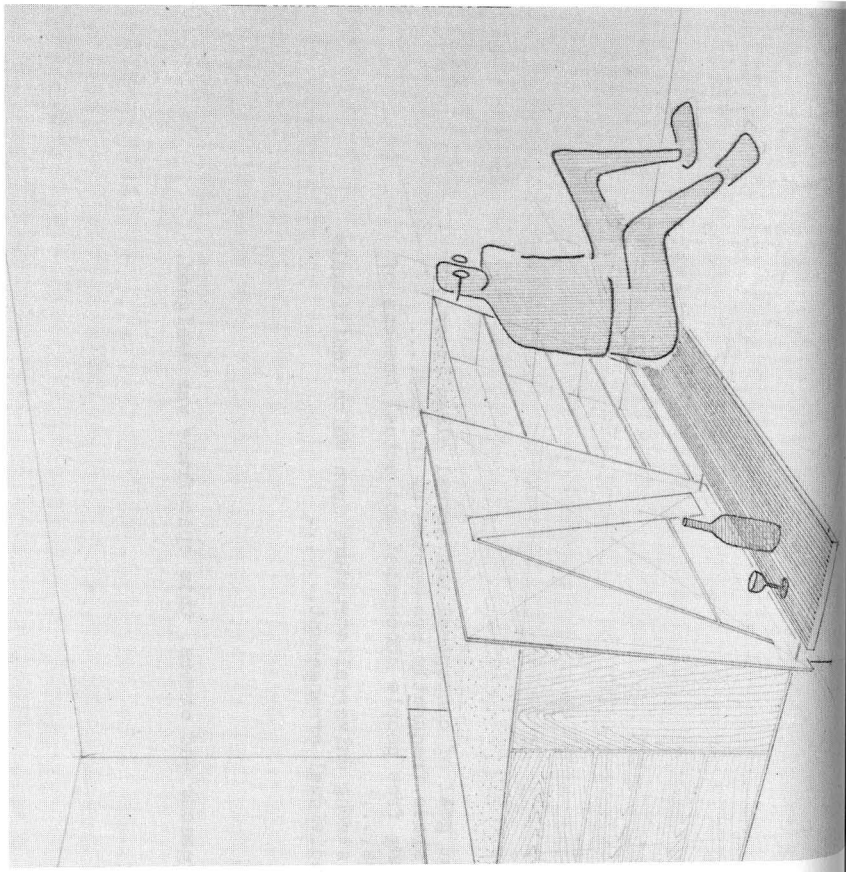

This small LIVING STRUCTURE has fully integrated storage drawers, safety panels, bookshelves, low bench-table and bed on top.

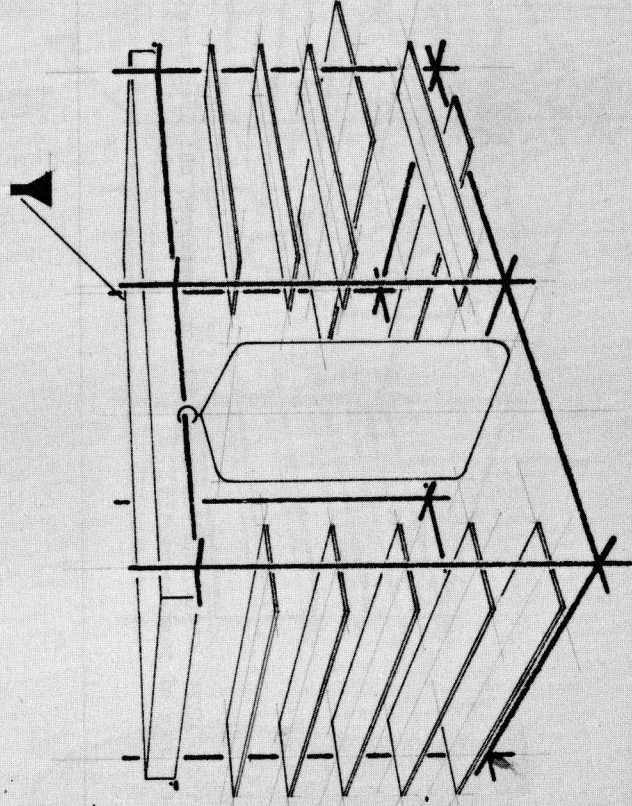
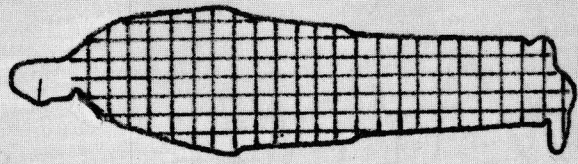

ON ASSIGNMENT OF Y STREET TRUCK
DAYS FROM 11:00 AM TO 1:00 PM
FROM 11:00 AM TO 1:00 PM
MYAL BRANCH FOR THE MARINA CIRCUIT
SAY THANKS TO THE MANAGEMENT FOR J

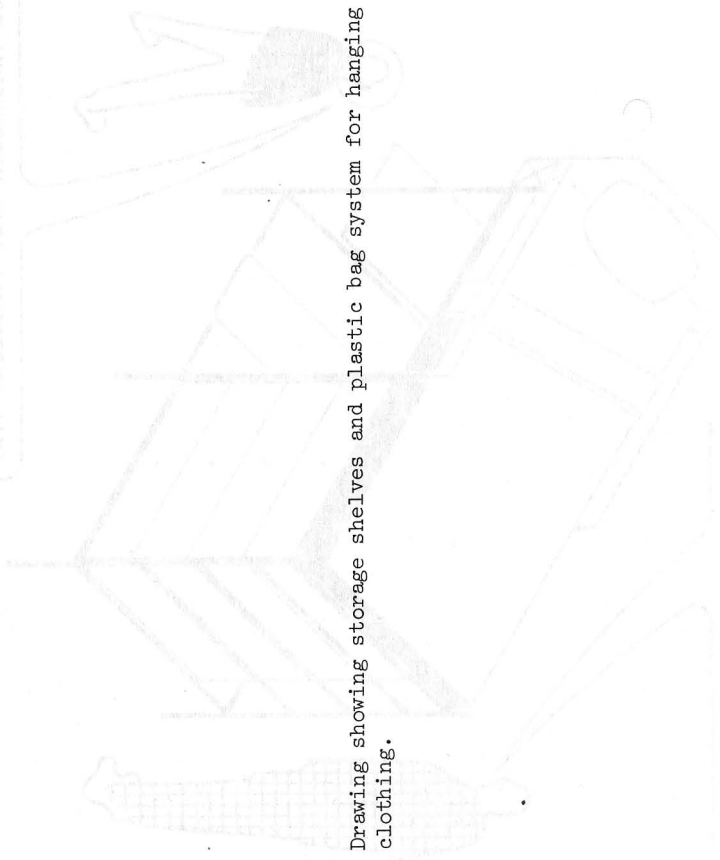

ON ASSIGNMENT OF Y STREET TRUCK
DAYS FROM 11:00 AM TO 1:00 PM
FROM 11:00 AM TO 1:00 PM
MYAL BRANCH FOR THE MARINA CIRCUIT
SAY THANKS TO THE MANAGEMENT FOR J

Drawing showing storage shelves and plastic bag system for hanging clothing.

OLD-FASHIONED FURNITURE TURNS THE ROOM INTO A 'BEDROOM' & CUTS OFF OTHER POSSIBILITIES FOR USE. THIS LIVING STRUCTURE 3.0 X 6.5 FREES 80% OF THE SPACE FOR INDIVIDUAL ACTIVITIES. IT'S A SPACE AMPLIFIER!

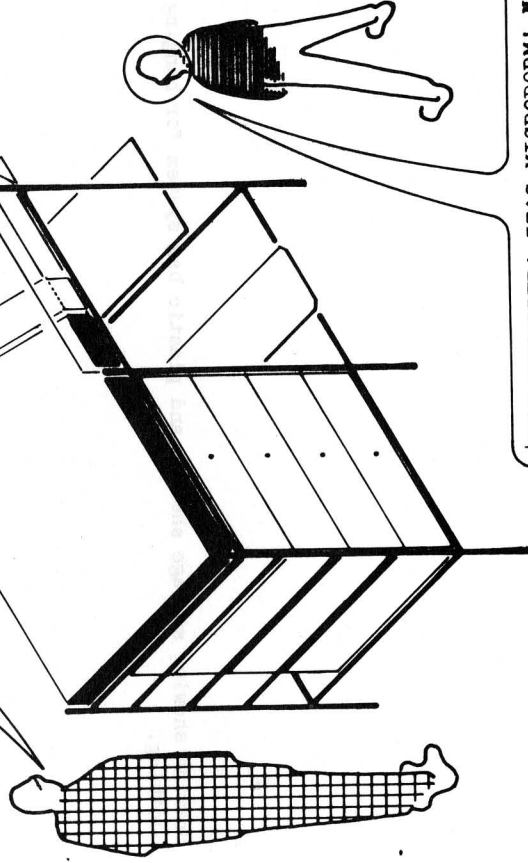

IT'S SUPERBED! IT'S MICRODORM! NOW I HAVE ENOUGH ROOM FOR THE MEMORY CIRCUIT FABRICATION IN THE QUASAR PROBE, THE LASER SET-UP, AND SOME 8MM FILMING! THIS MATRIX WILL ALSO SOLVE MY LACK OF TERRITORIALITY ON A VIABLE LEVEL!

This version of the MICRODORM was manufactured with a wood frame and sold in department stores for \$300.

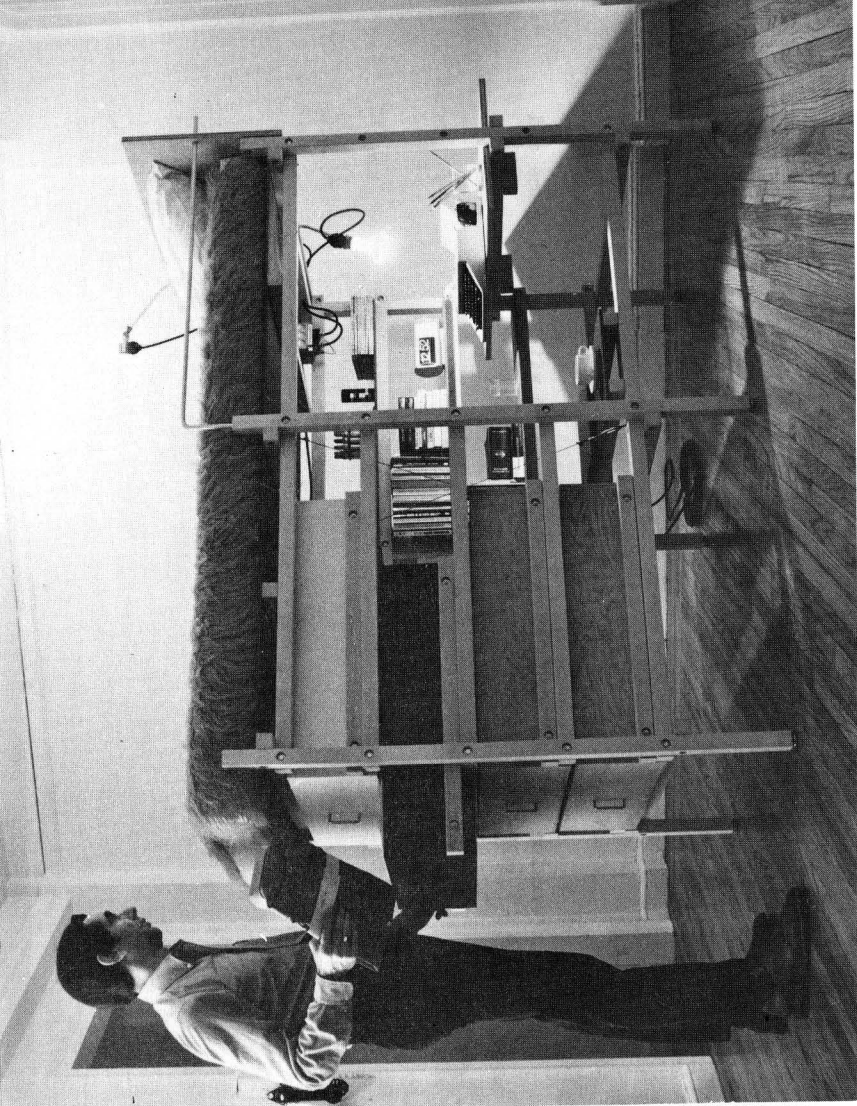

The huge sliding bins offer almost twice the storage cubage of a traditional chest of drawers.

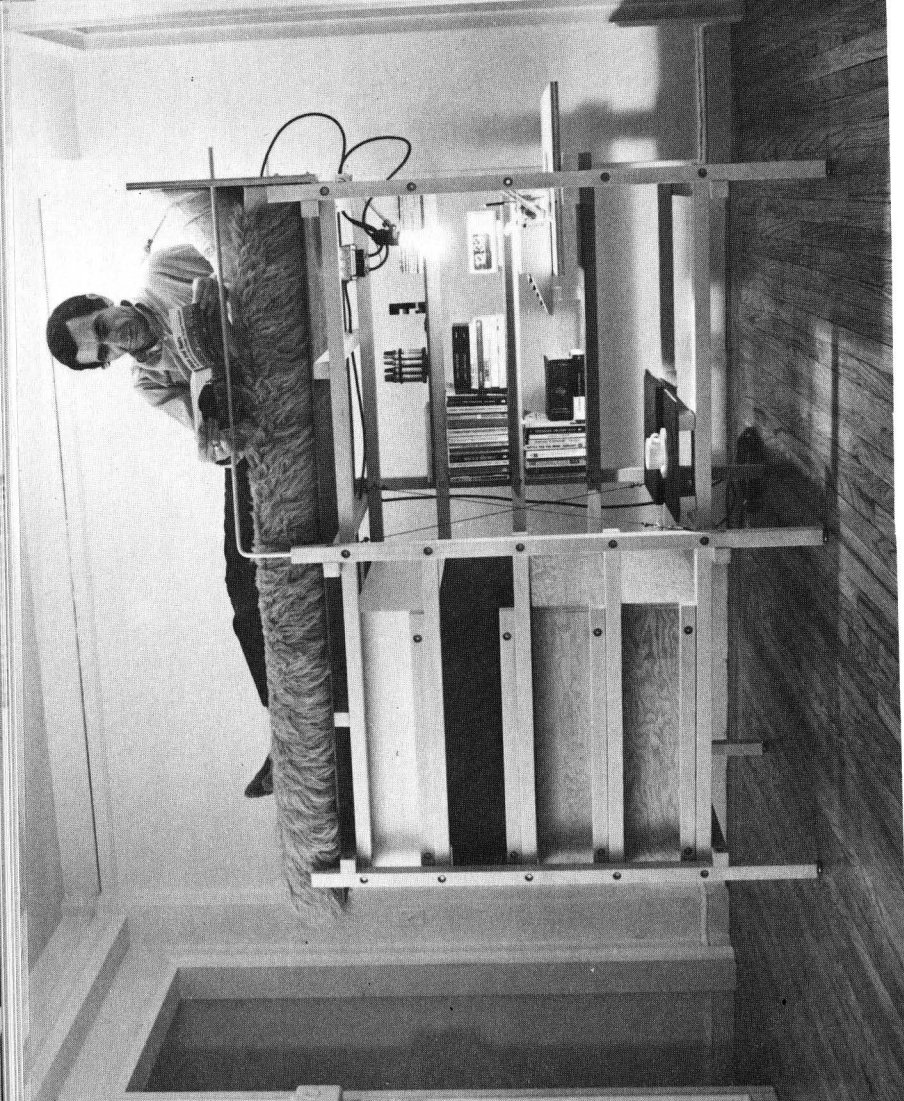

The study area under the bed is equipped with bookshelves, worktable, sliding bench and quadruple electrical outlets for tooling. Lamps are also integral. Drawer slide supports form a ladder to reach the bed. All this is within the floor space taken up by an army cot.

THE NEW YORKER MAGAZINE SAID THAT SUPERCHAIR WOULD BE GREAT FOR 'THE LATTER-DAY OBLOMOV' & DOMUS CALLED IT 'TUTTO IN UNO.' KEN ISAACS CALLS IT LIVING STRUCTURE 3.5 X 3.5 & IT'S THE FINEST PLACE TO THINK, READ OR LISTEN TO MUSIC. LET DOWN THE BACK & IT'S A BED!

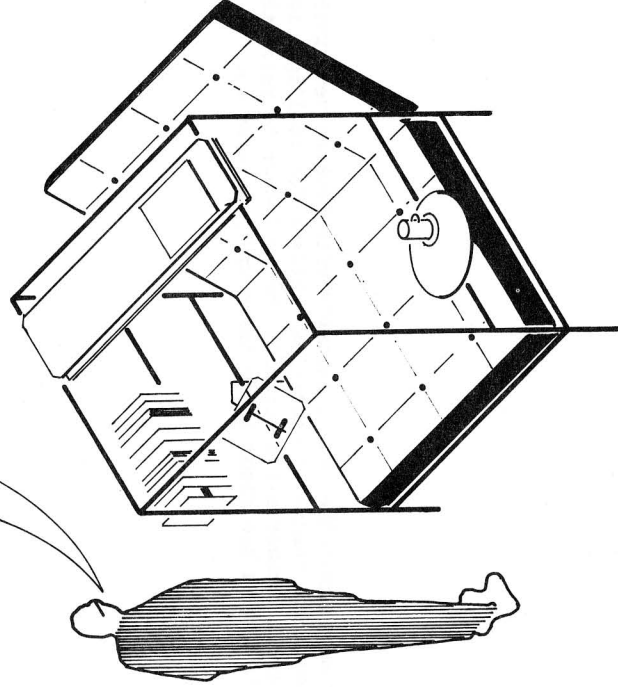

The SUPERCHAIR, although incorporating a traditional furniture name, provides multiple uses and experiences.

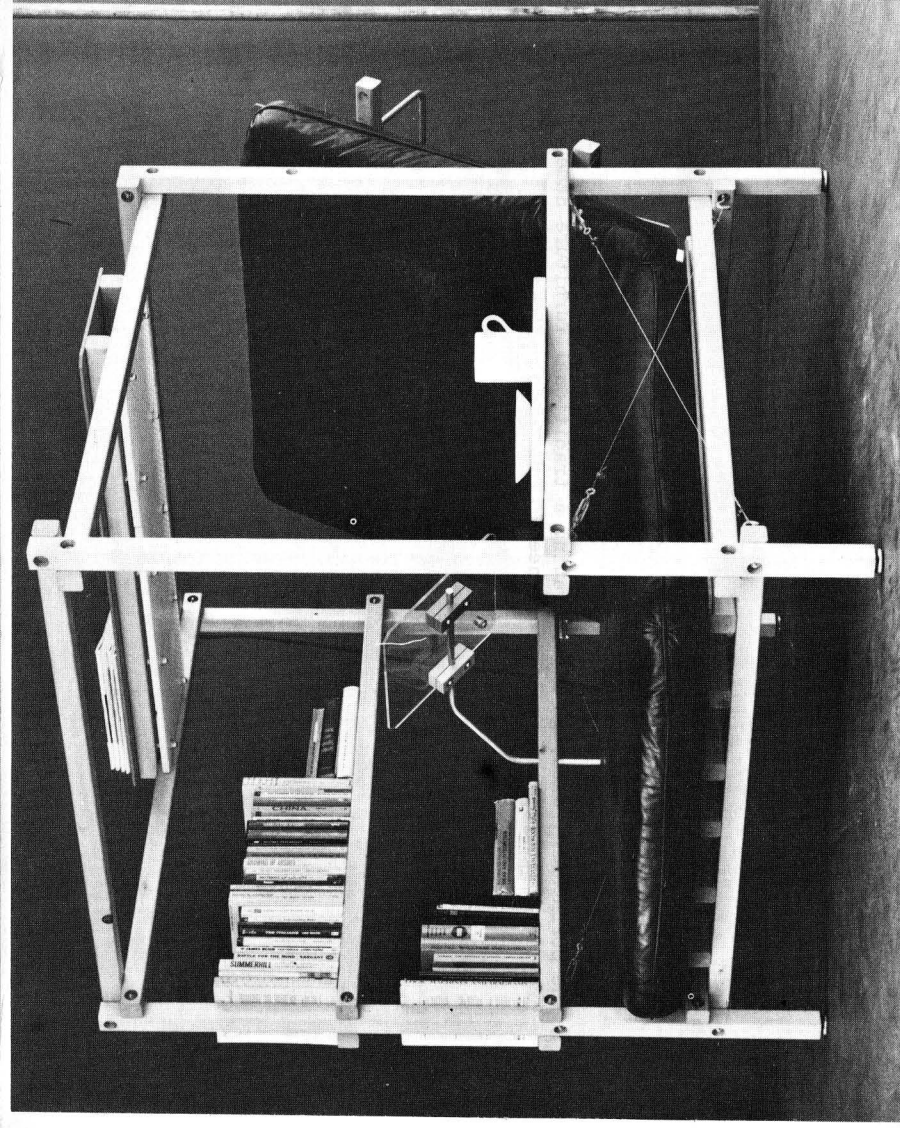

The sliding overhead light can be positioned to suit the user as can the moveable marble table.

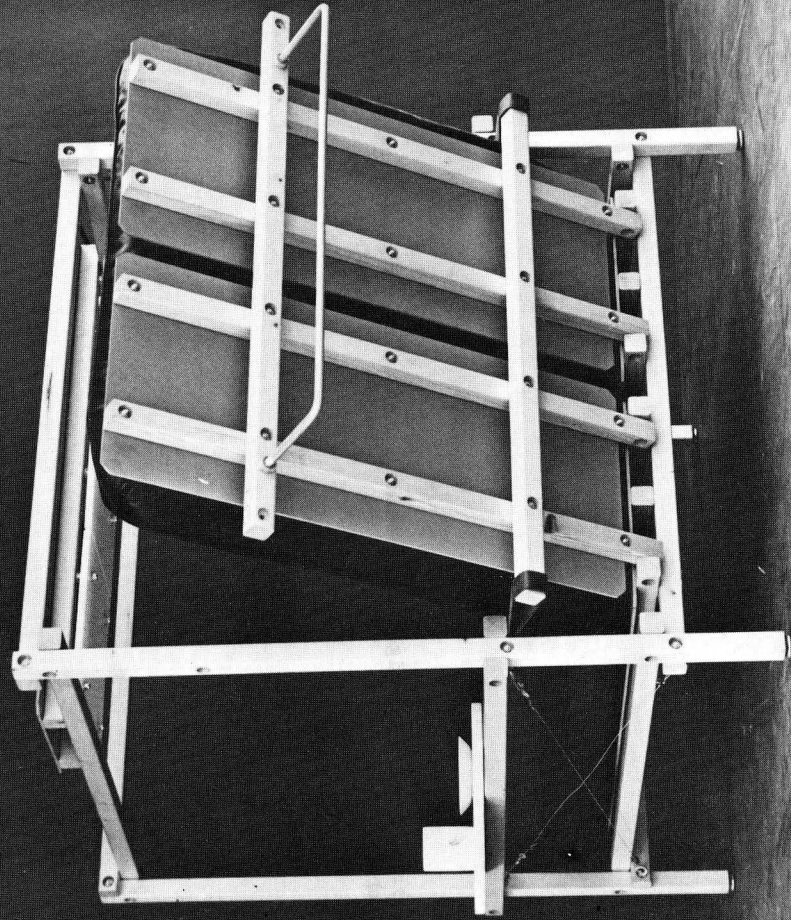

View showing back construction and leather straps used to hold back in position.

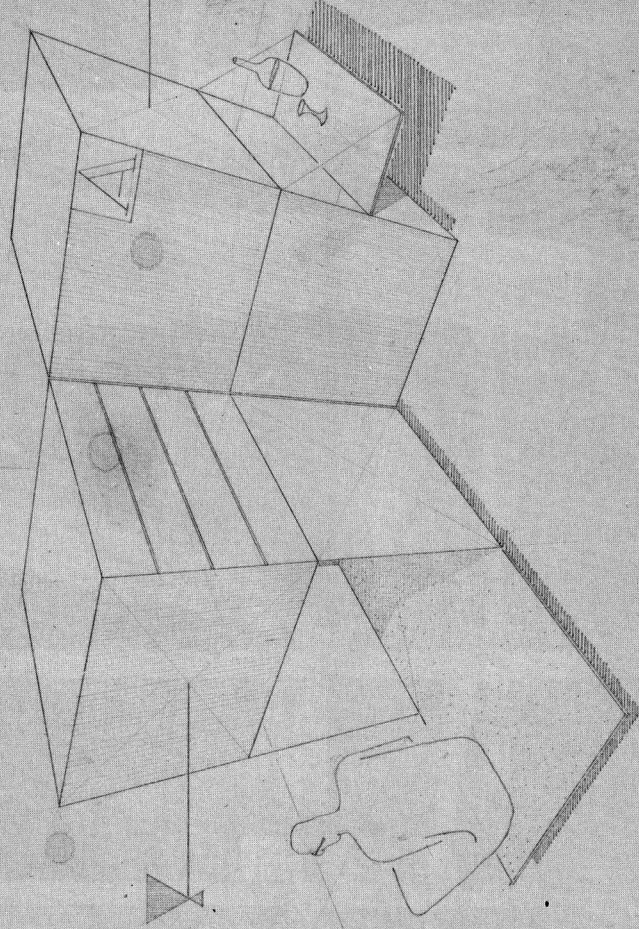

This is one of the smallest LIVING STRUCTURES. Only 3' square and 6' high, the storage is above with the bed folding out below. There is an integral light and folding table. The entire unit moves easily on casters.

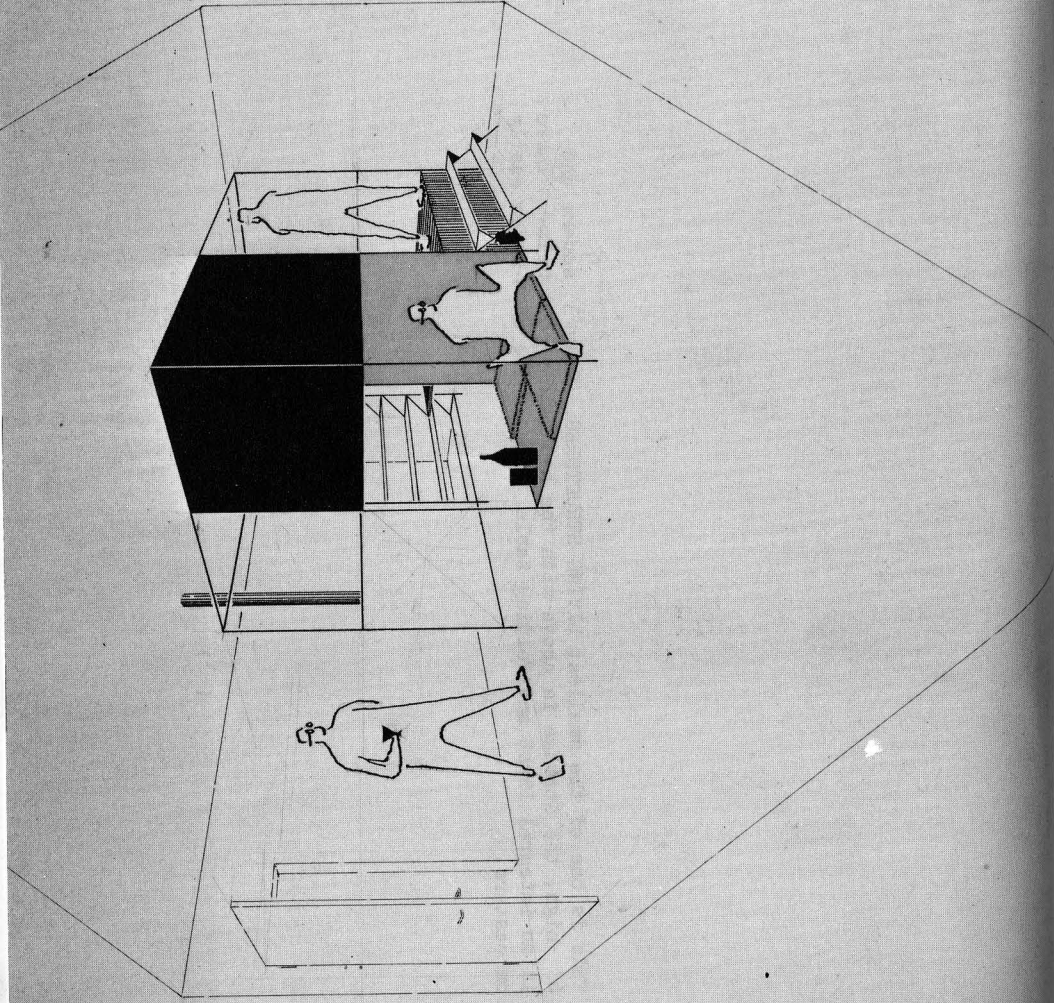

This large LIVING STRUCTURE is 8' square and the sleeping surface is reached from a mezzanine with steps.

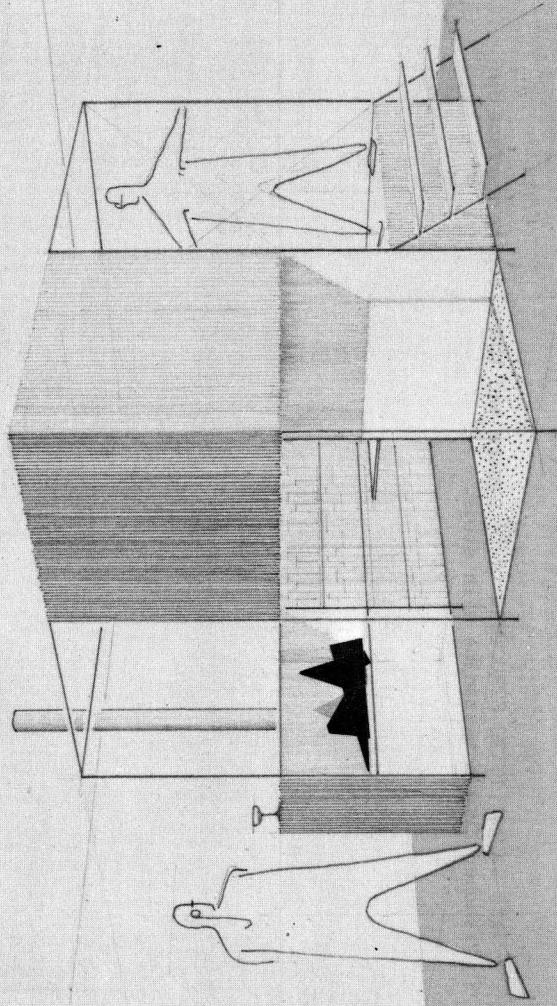

The largest LIVING STRUCTURES are flexible enough so that even a fireplace can be incorporated.

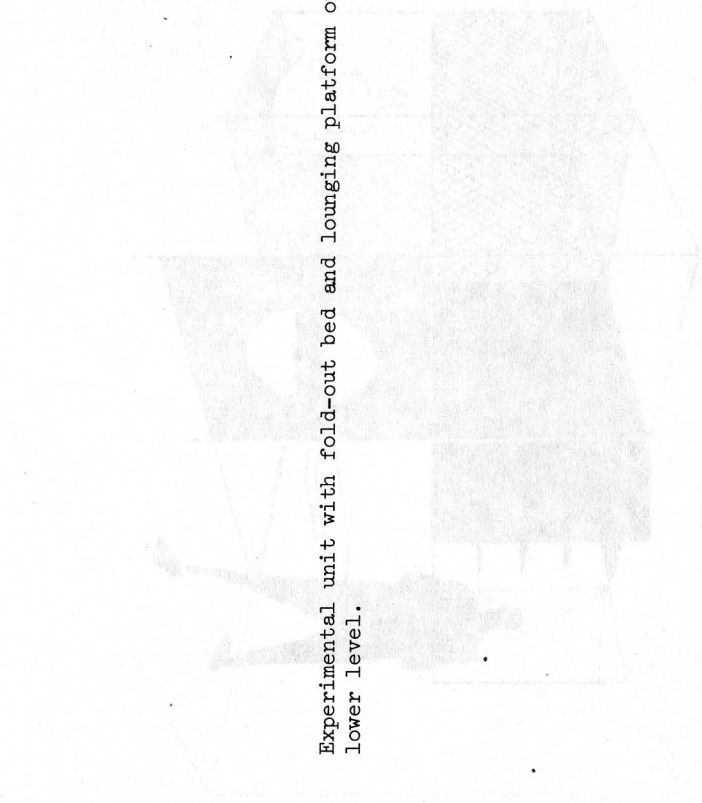
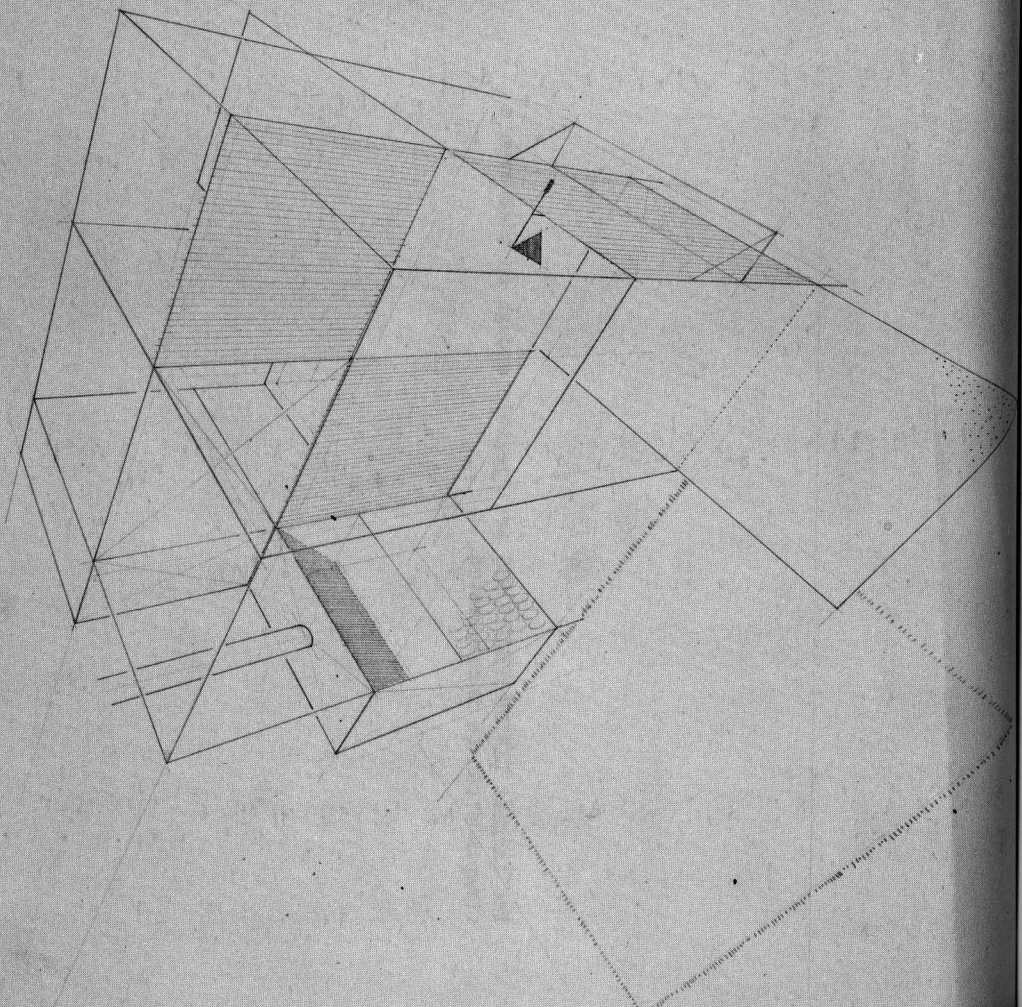

Experimental unit with fold-out bed and lounging platform on the lower level.

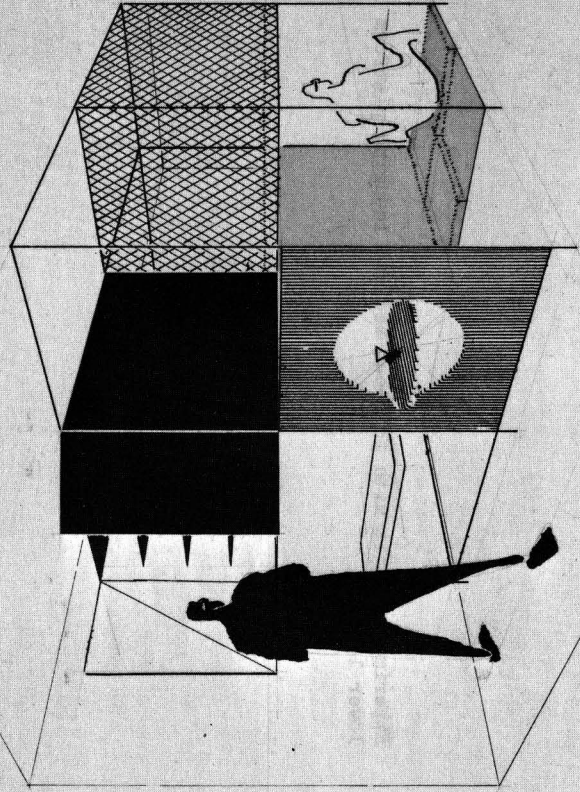

Experimental unit with cooking cabinet at far left.

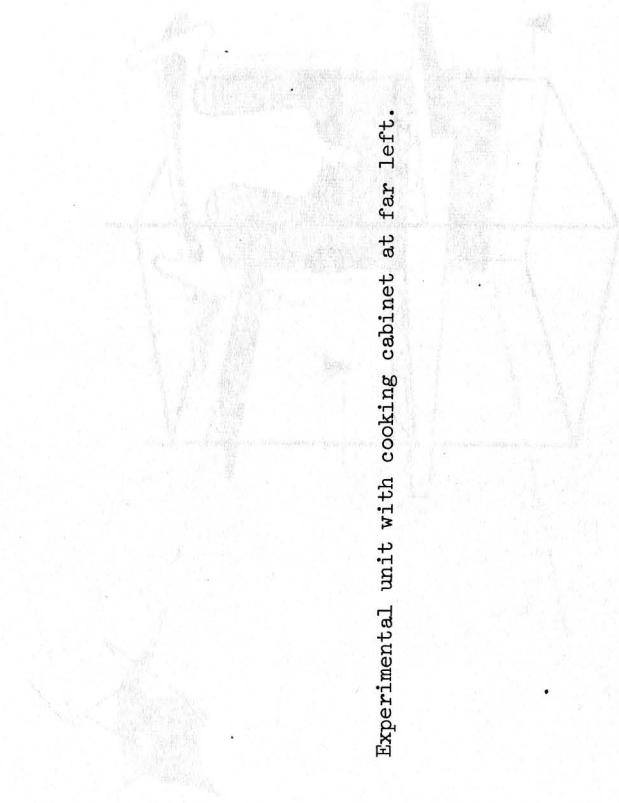

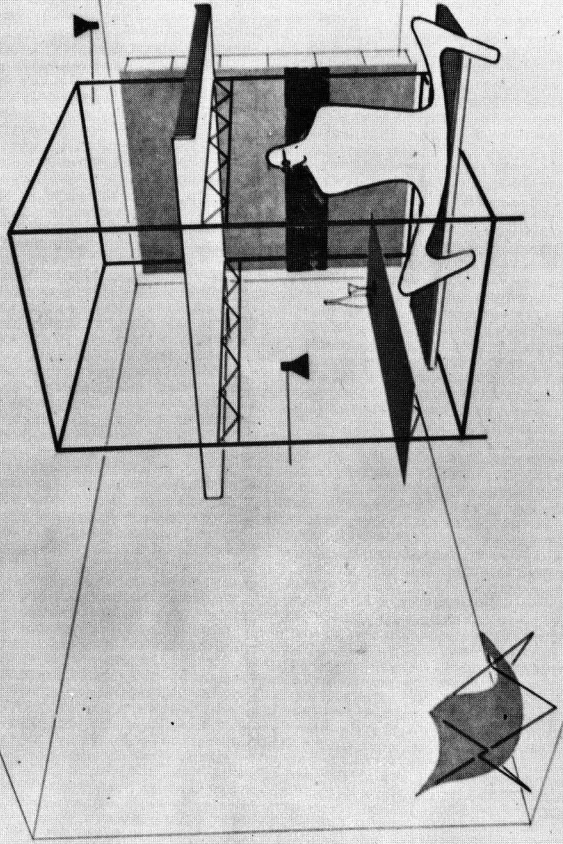

LIVING STRUCTURES may be built of all kinds of materials from steel tubing to bamboo. This one is of aluminum tubing with welded trusses supporting the bed and table. The cooking shelves are behind the panel which has a vertical pass through opening.

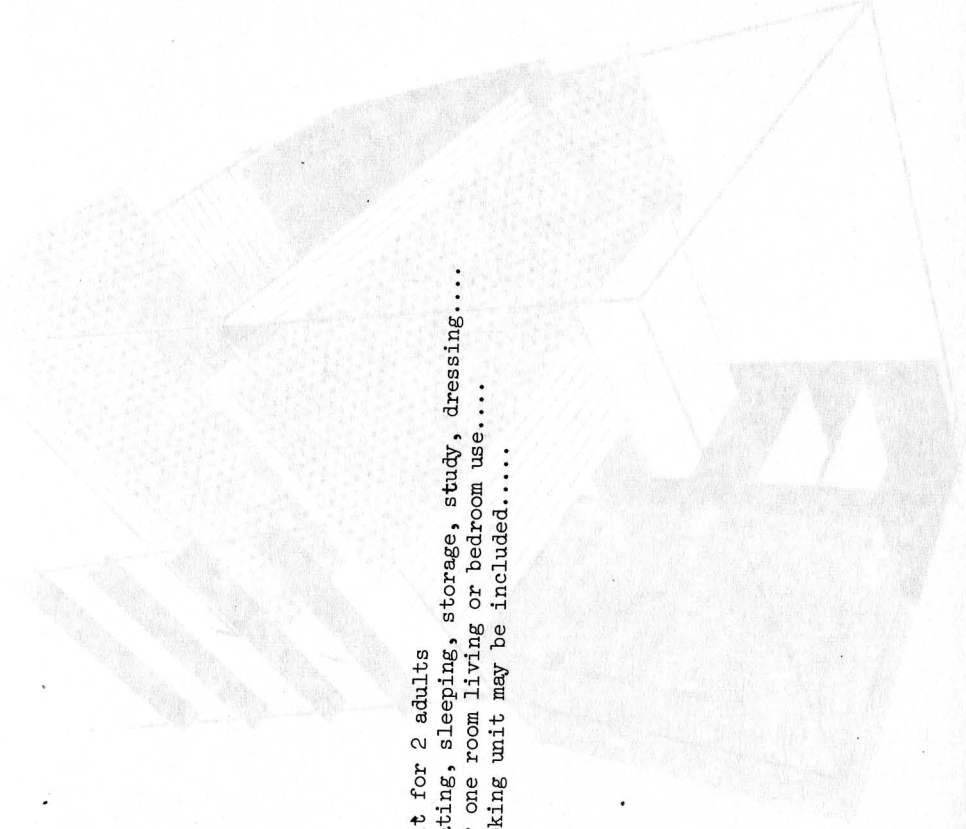
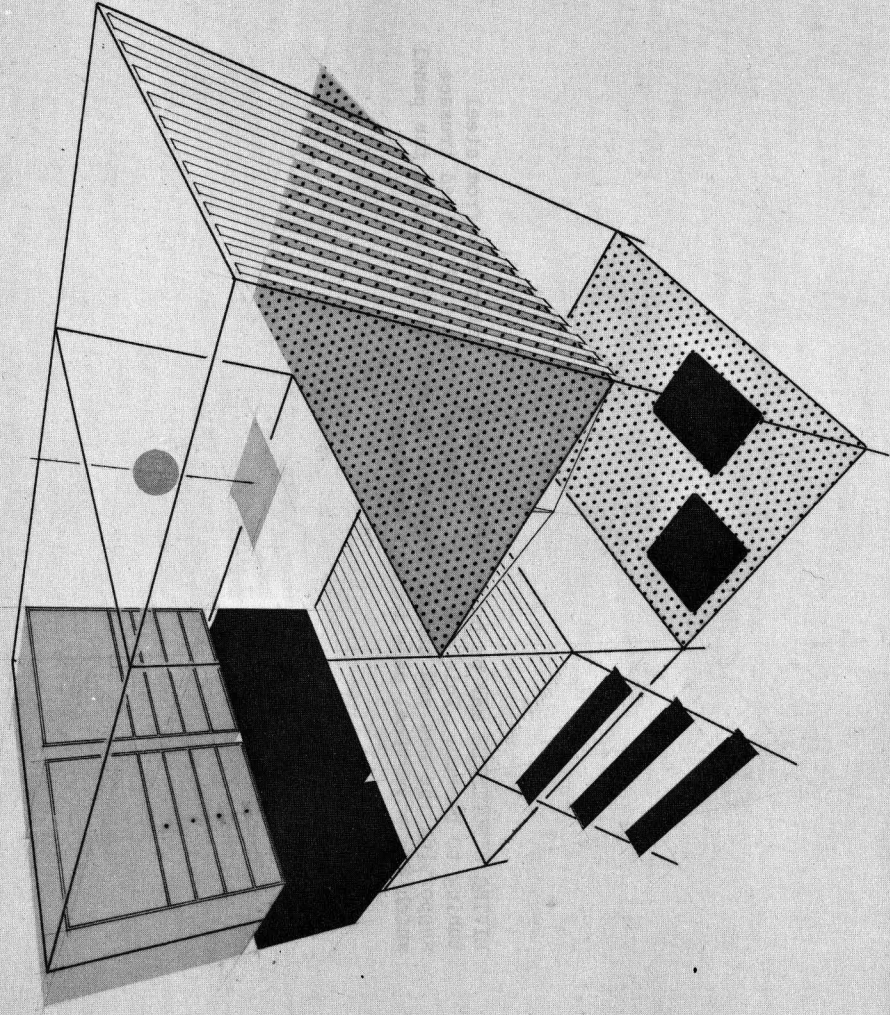

unit for 2 adults
seating, sleeping, storage, study, dressing.....
for one room living or bedroom use....
cooking unit may be included.....

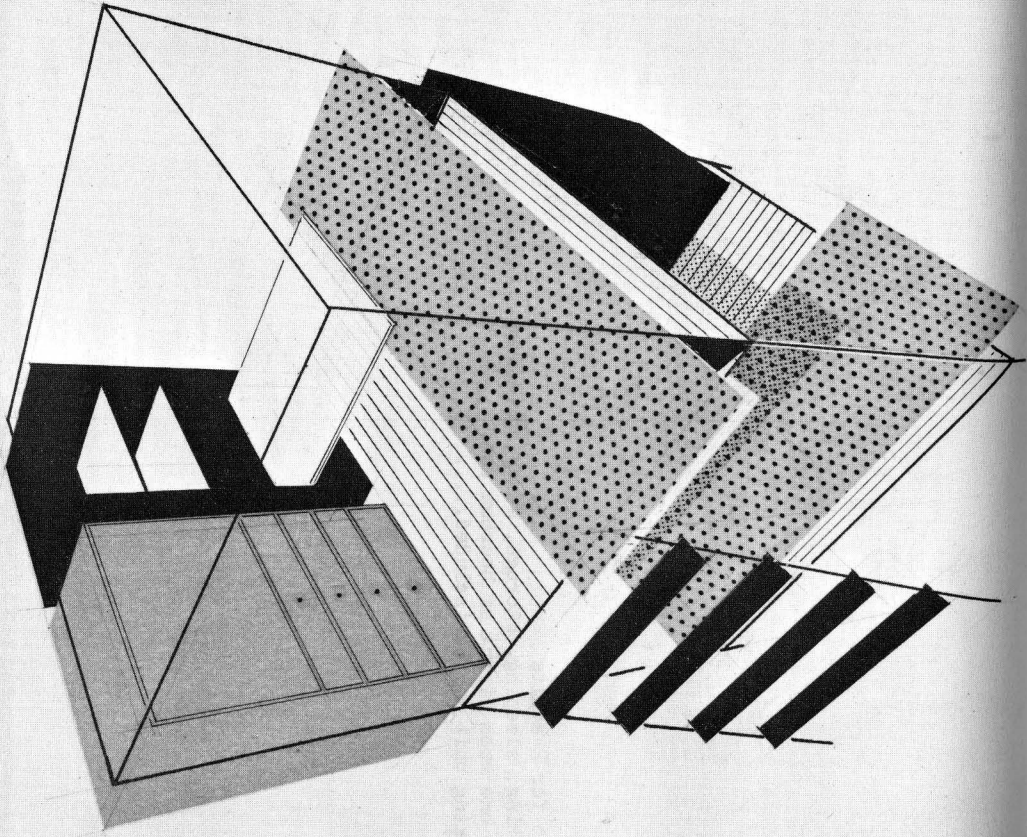

unit for 2 children
sleeping, storage (toys and clothing), work,
play, possession, specialness.....
to supply best physical organization as basis
for training and understanding the world.....

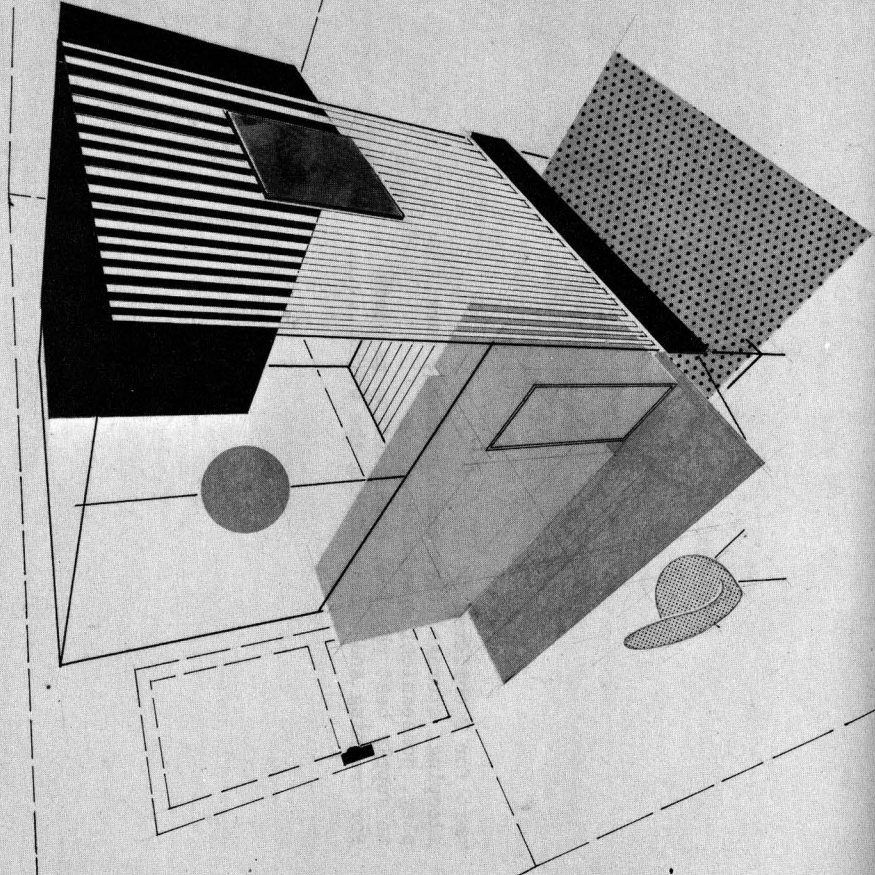

unit for large bedroom....
using 2 56" basic modules.....
furnishing seating and study facilities on a good
scale
more screen panels may be added.....

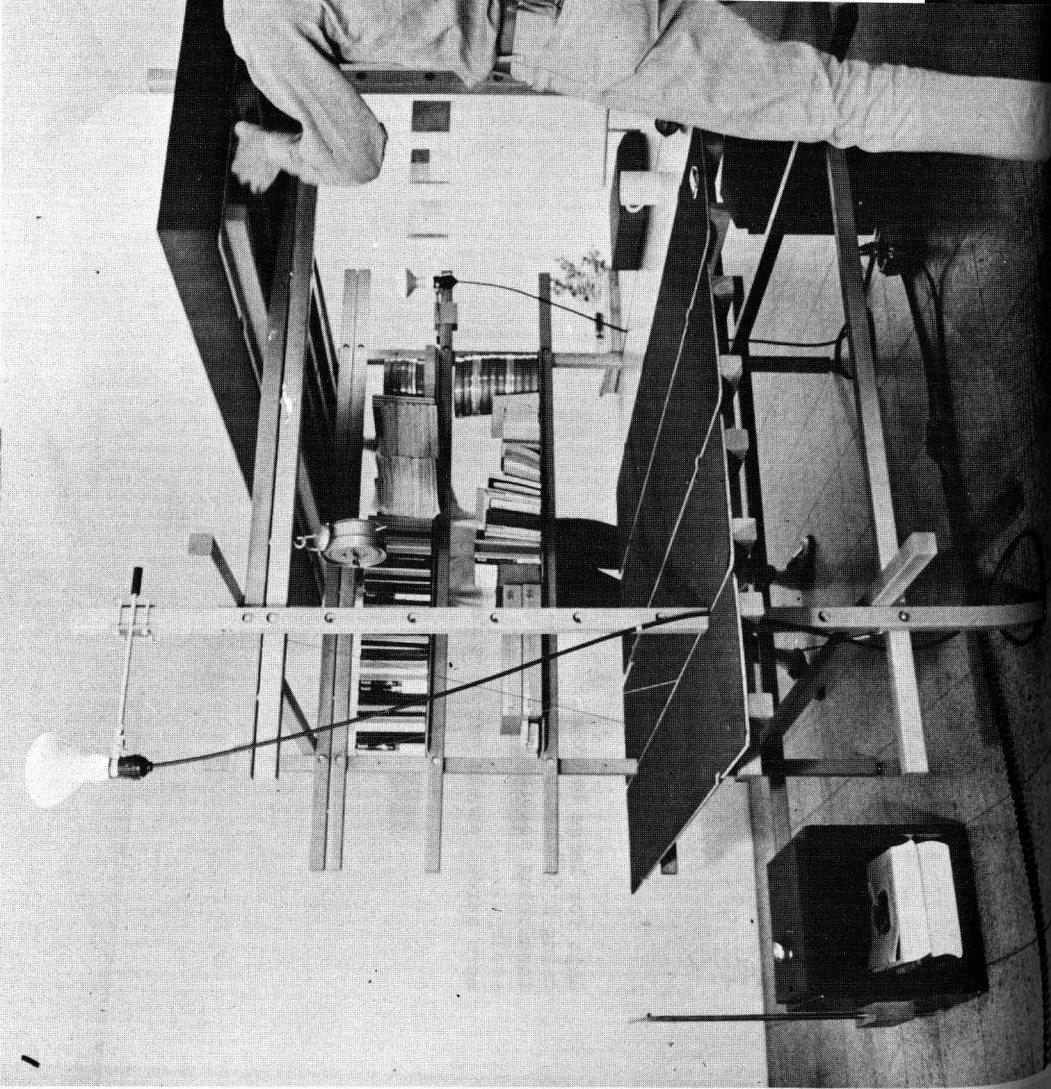

The Chicago LIVING STRUCTURE 6 x 6 consists of a wooden frame of members $1\frac{1}{2}$ " square bolted in the non-collapsing joint at the corners.

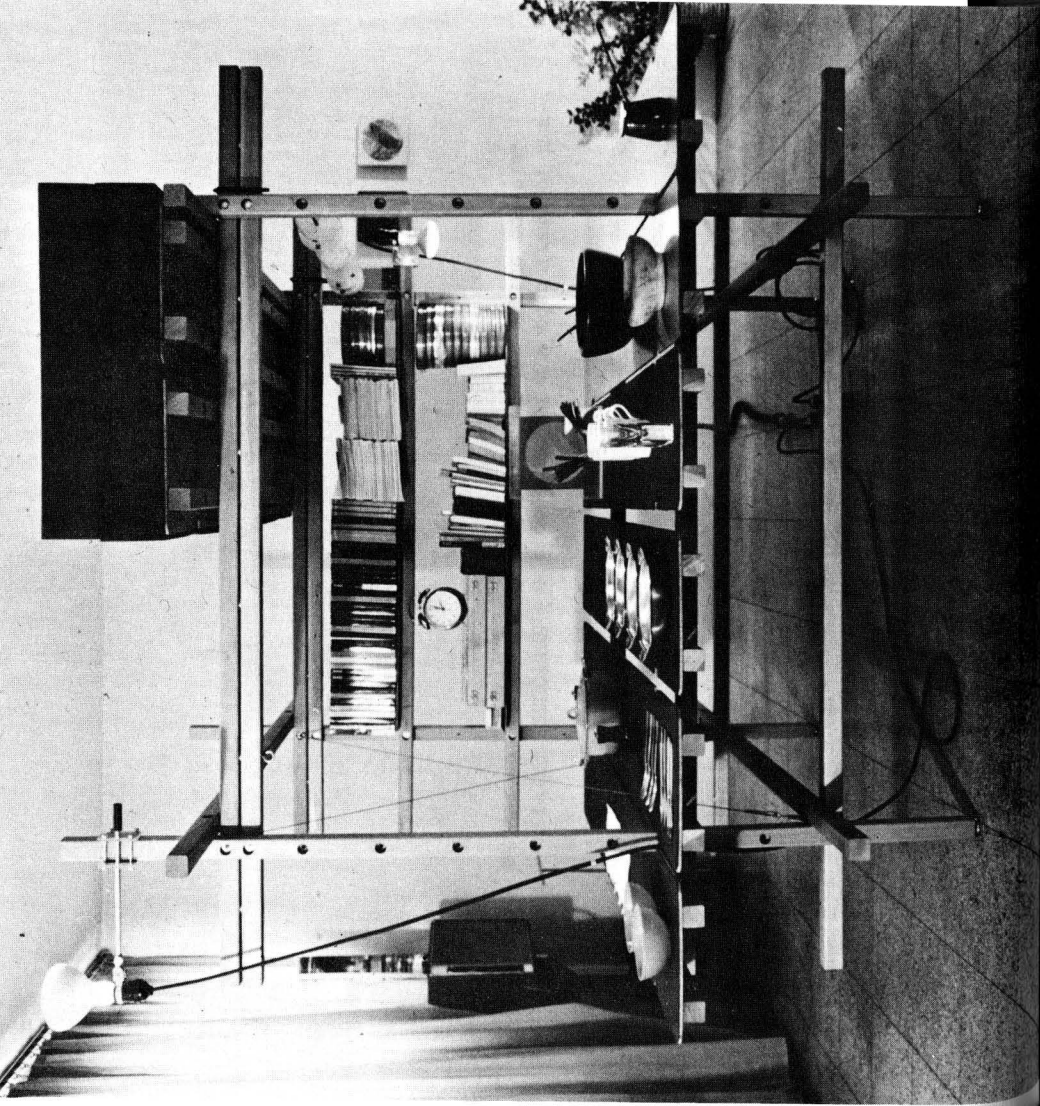

The horizontal surfaces of the LIVING STRUCTURE 6 x 6 are moveable modular panels which can be shifted in response to changing need patterns.

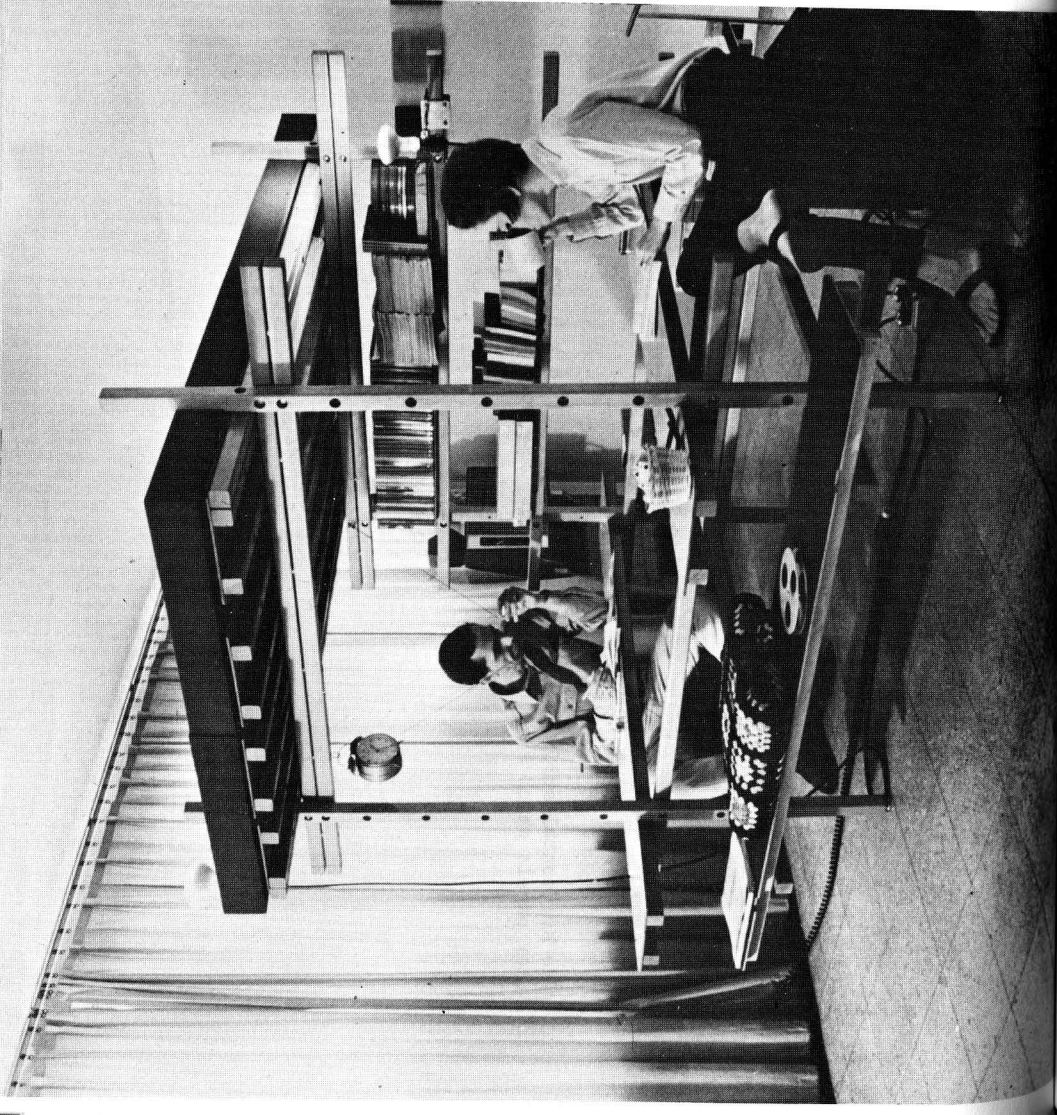

Various combinations of tables may be constructed easily without tools.

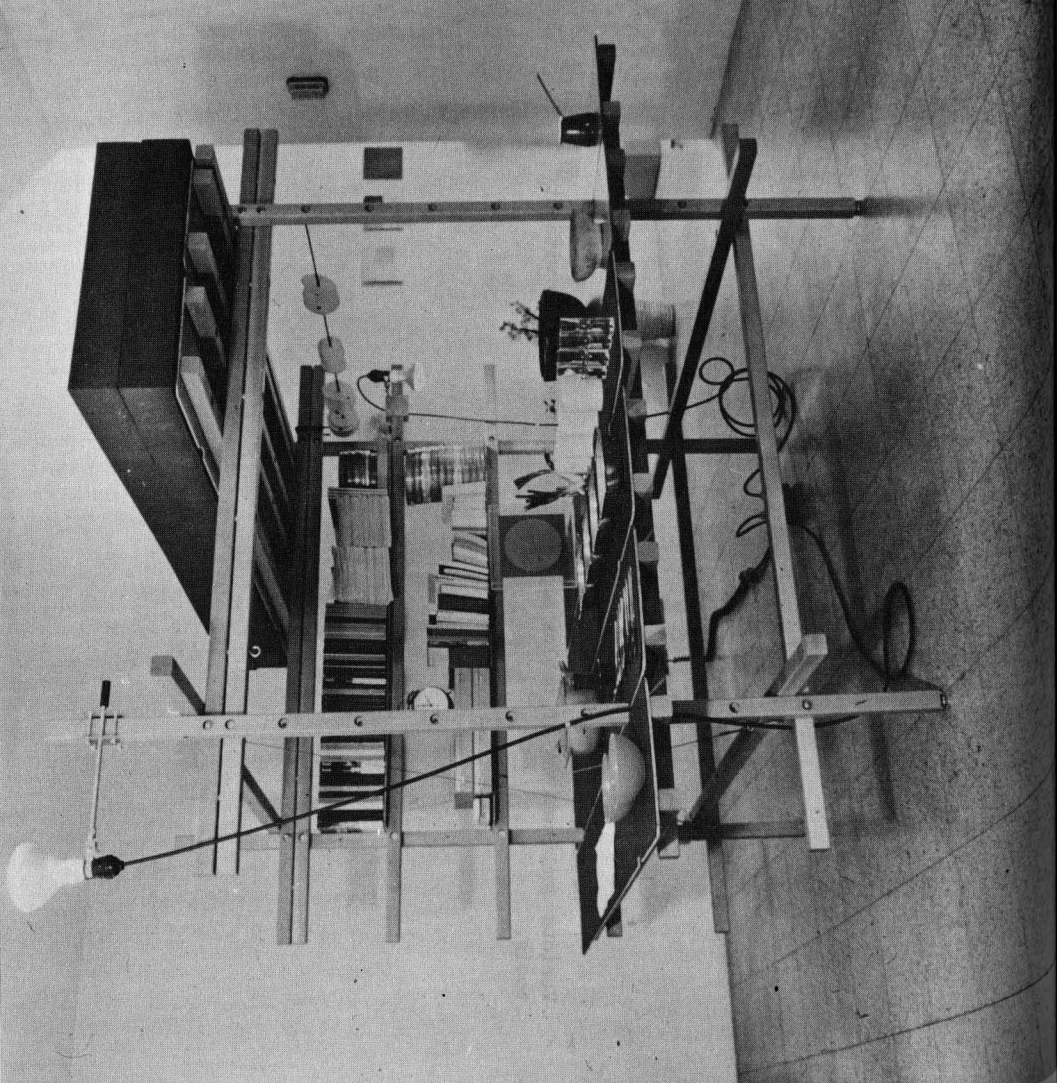

All the members of the unit are 72" long and pack in a case less than 12" square. Easy to move and ship, LIVING STRUCTURES are also simple and inexpensive to produce. Initial cost to the user is a fraction of the aggregate cost for furniture of the old culture.

INFORMATION STRUCTURES

The only humane and effective way to break the negative grip of antique culture is with INFORMATION.



A PHOLAGE is a group of photographs documenting the human condition assembled without the strictures of editing.

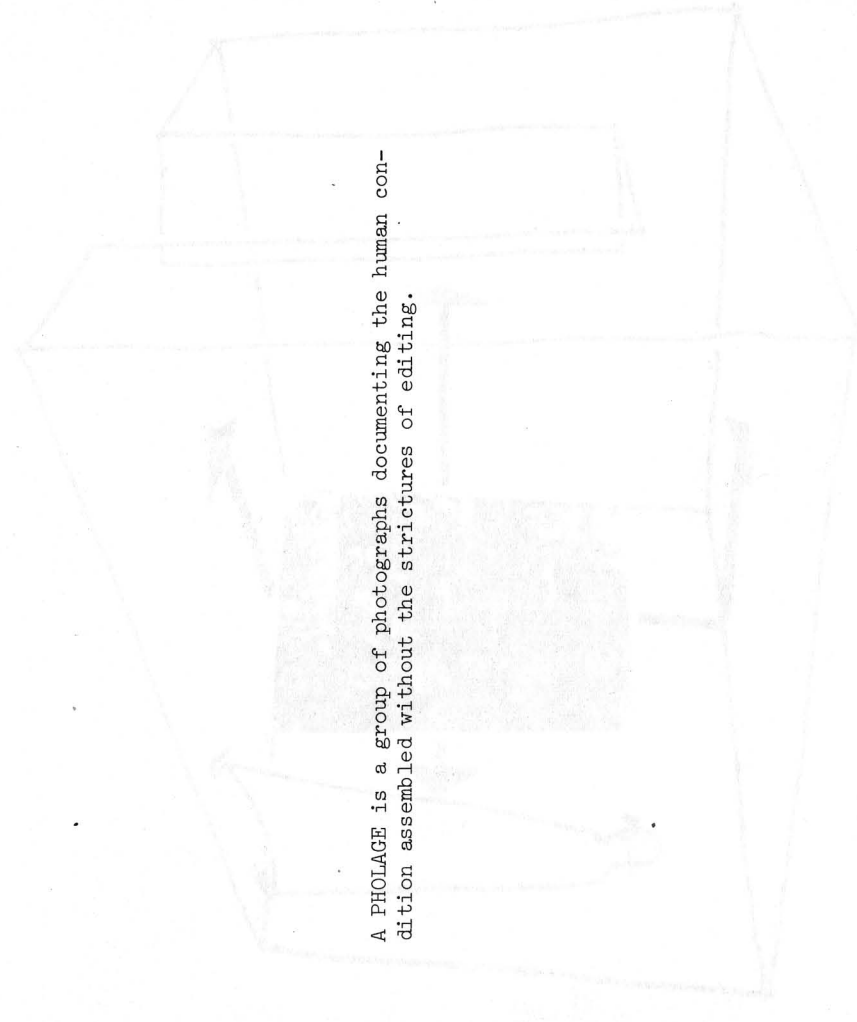

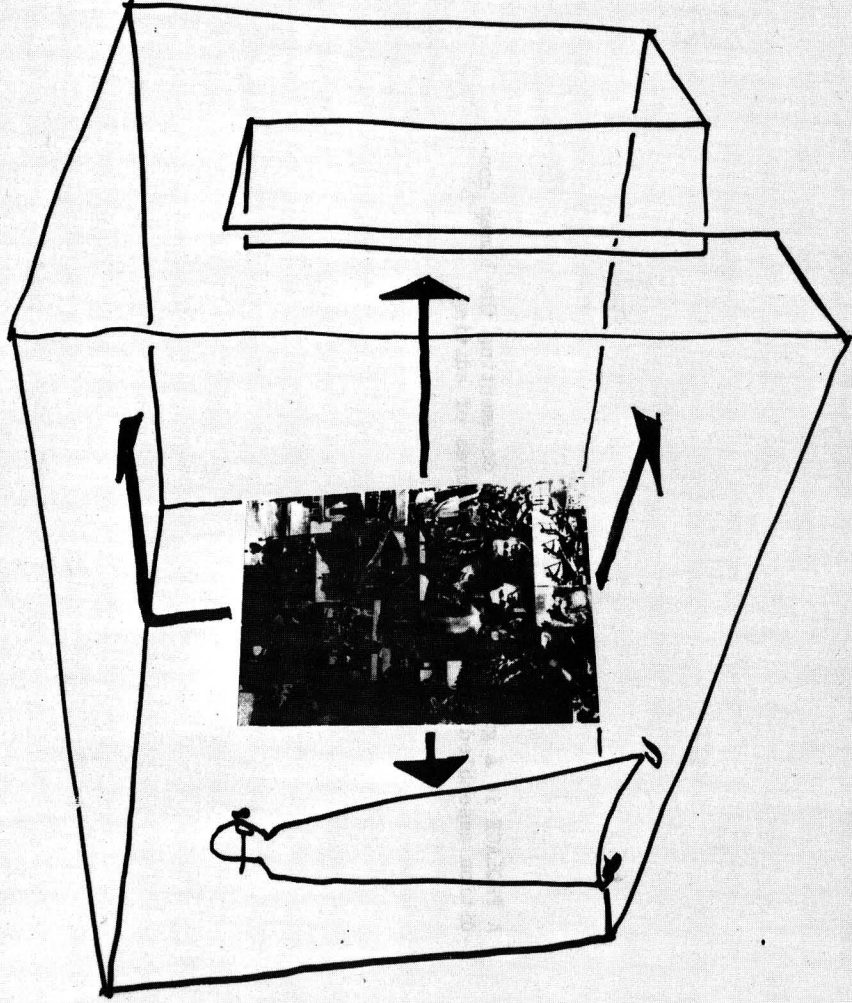

I covered all the surfaces of a room $9\frac{1}{2}$ x 11 feet with PHOLAGE. This construction of random informational material was originally intended to create an evocative situation. What occurred was that persons stimulated by this experience initiated exploratory correlative action on their own without additional exploratory was the primary break with traditional informational prompting. This was the primary break with traditional information assemblies and the basis for development of informational 'translations' and total 'information structures.'

TRANSLATIONS

Translations are culture-breakers freeing the individual from the verbal confusions of standardized learning techniques. The process involves coding concepts and the invention of personal systems of equivalents which can be generally understood.

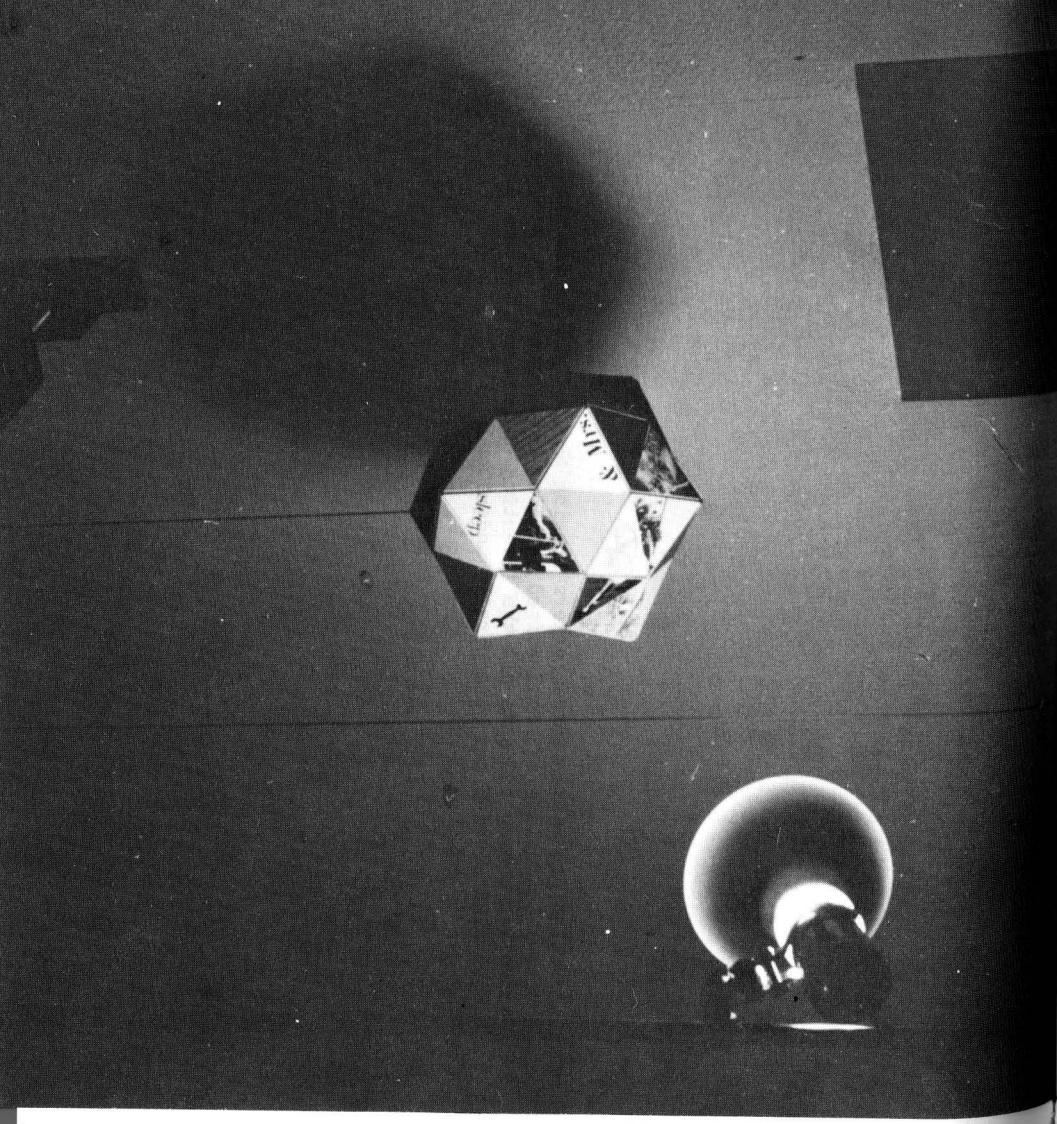

The schedule of translations is an expanding one beginning with an autobiographical equivalent system representing one's self.



After the translation of the self, the series would proceed to a translation of a friend and extend to a system translating a social event like the Little Rock school crisis in the 1950's.

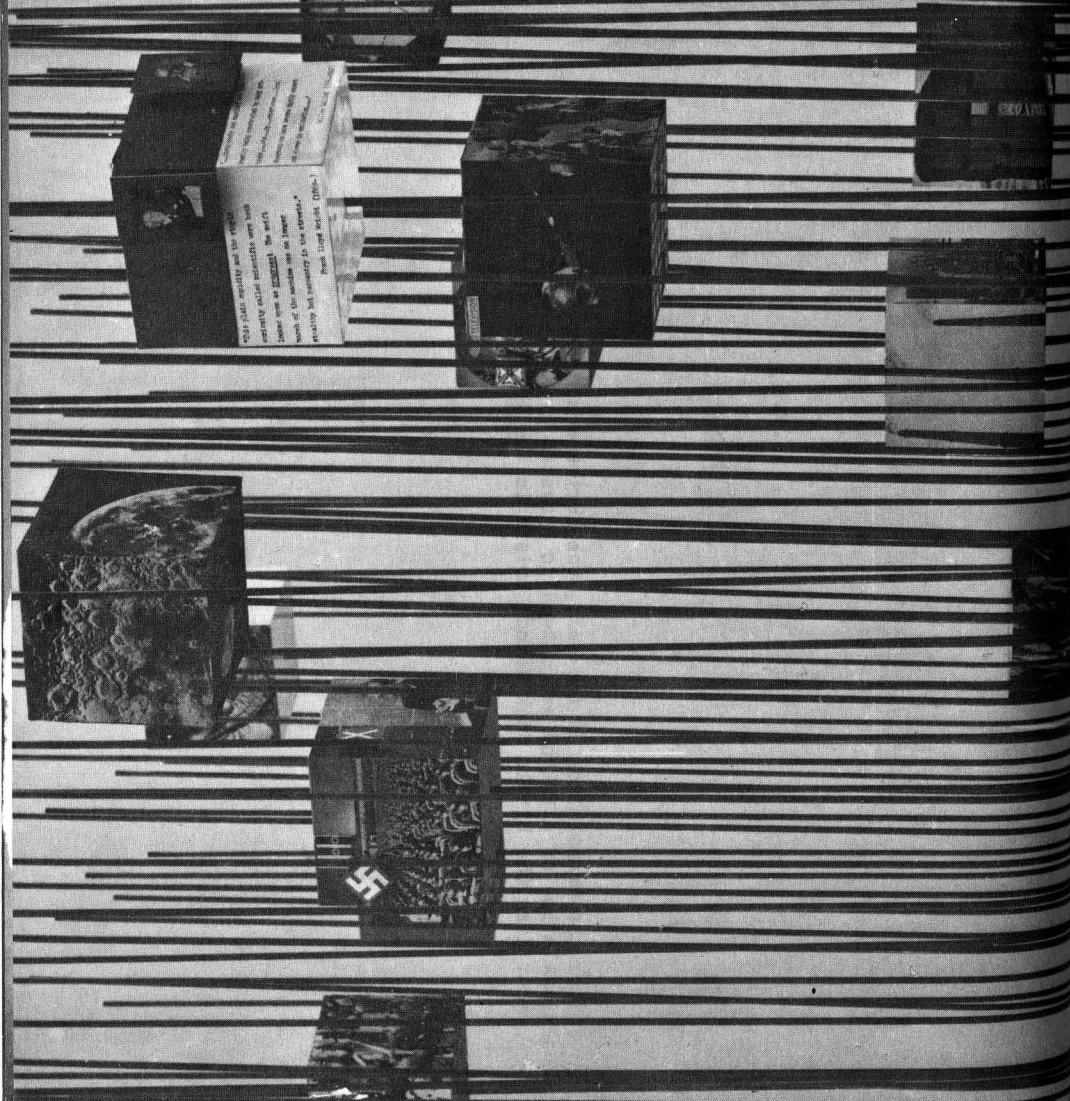

This translation of the Industrial Revolution is an example of a three-dimensional model using coded elements which make an historical era visible and concrete.

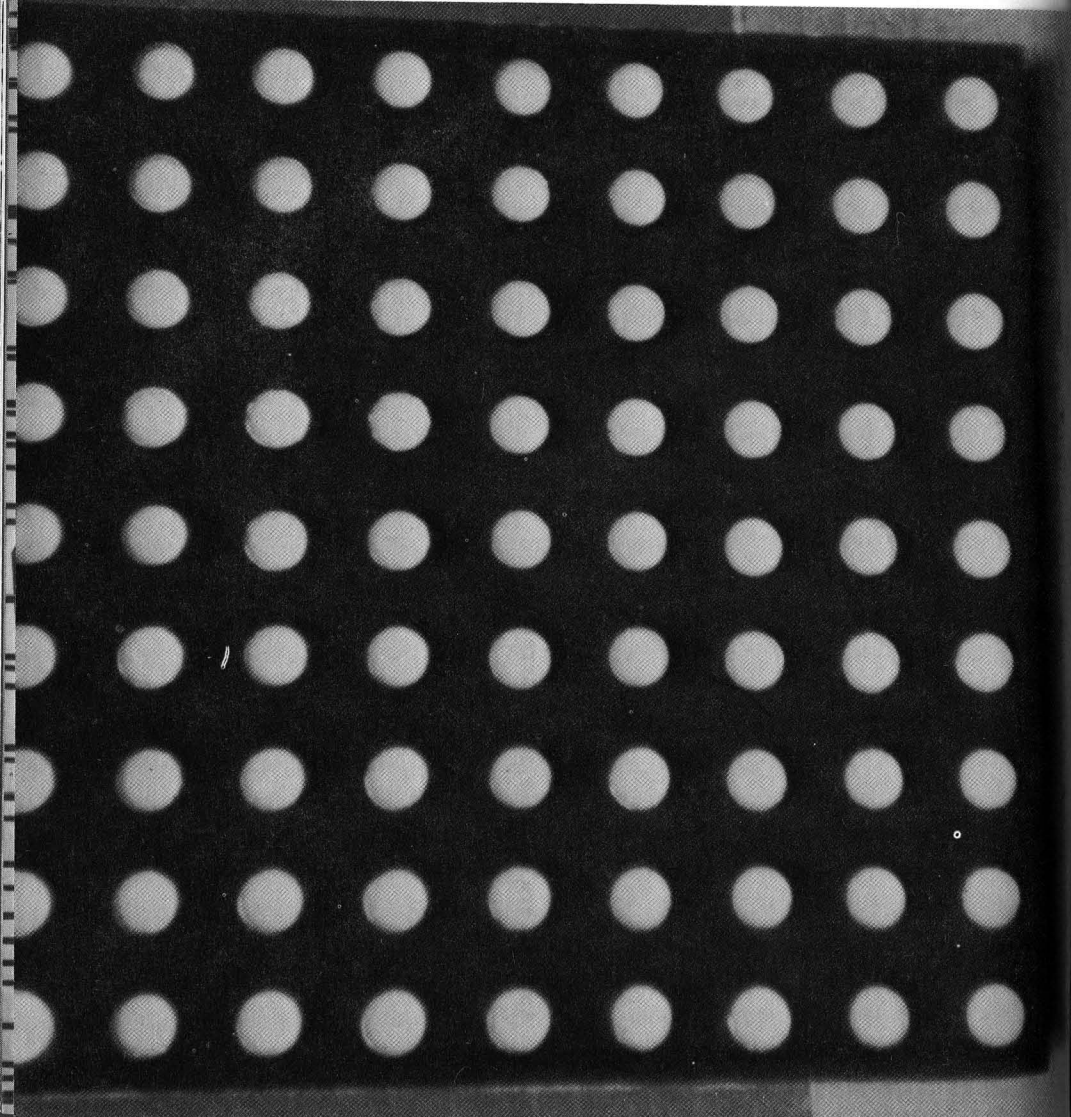

High order abstractions such as entropy are translated in this board
of flashing light patterns which has flexible programming.



The static patterns of the PHOLAGE were soon replaced with the fluid mobilities of simultaneous multiple slide and film projection on the inside surface of this MATRIX DRUM constructed at Cranbrook in 1956.

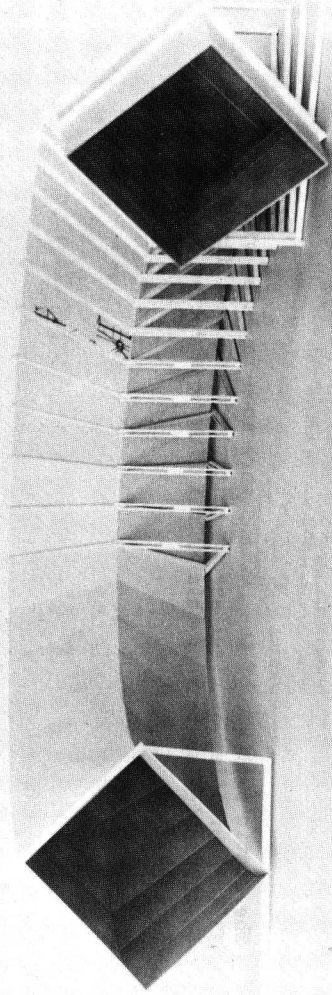

TORUS 1 was a new kind of information structure in which the person experiencing the transfer followed a circular path in pursuit of slide and film images.

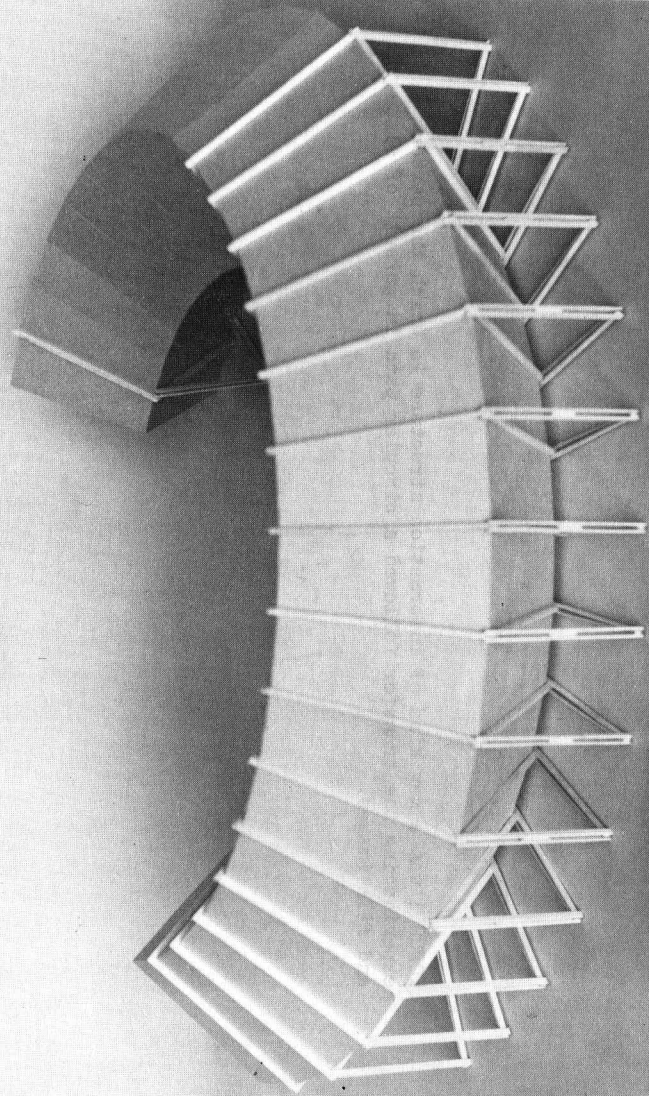

TORUS 1 was constructed of timber and flat panel elements for easy breakdown and shipping.

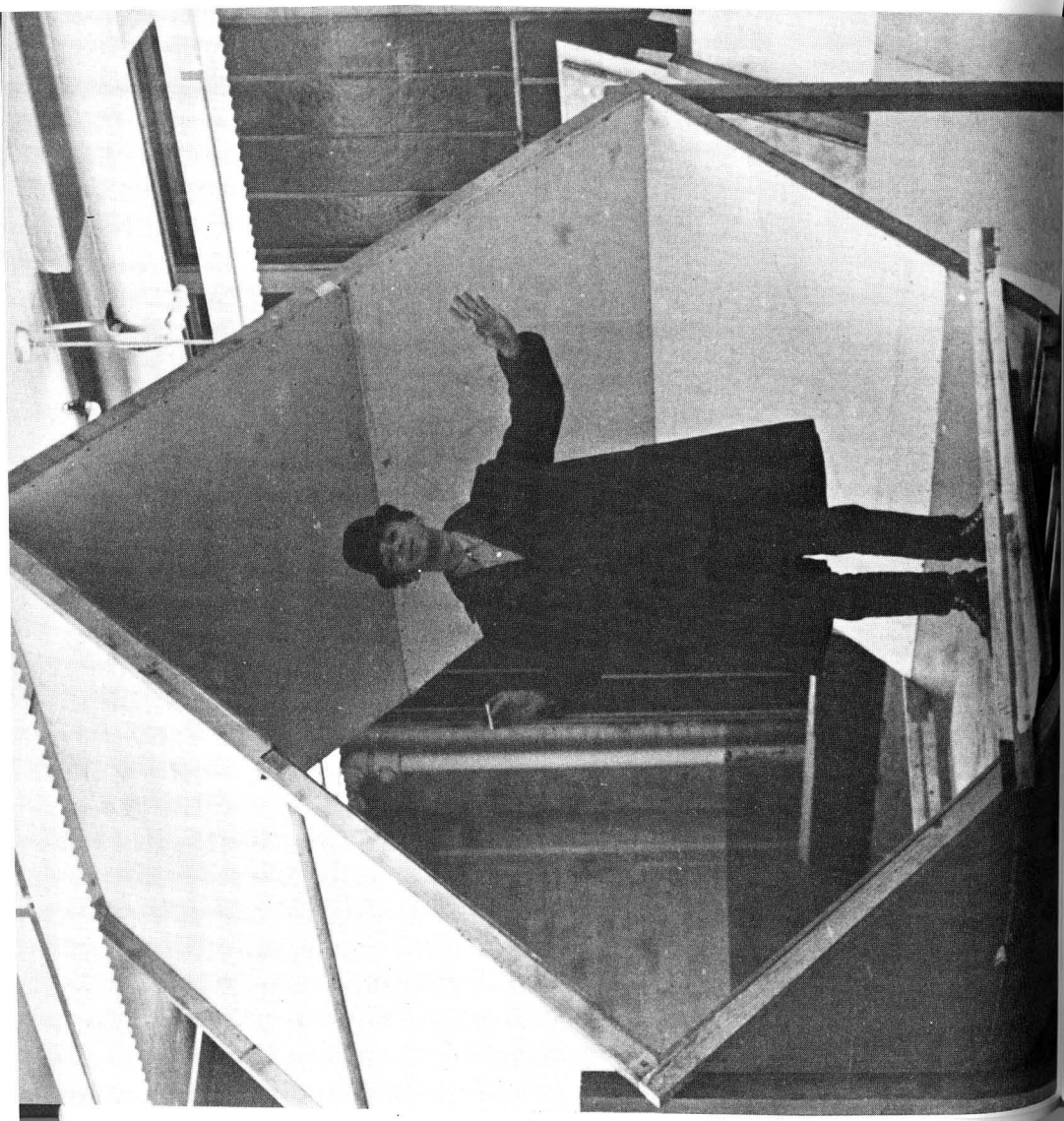

This full-scale cross-section mockup of TORUS 1, built at the Rhode Island School of Design, shows the relationship of the walkway to the four inclined projection surfaces which surround the participants.

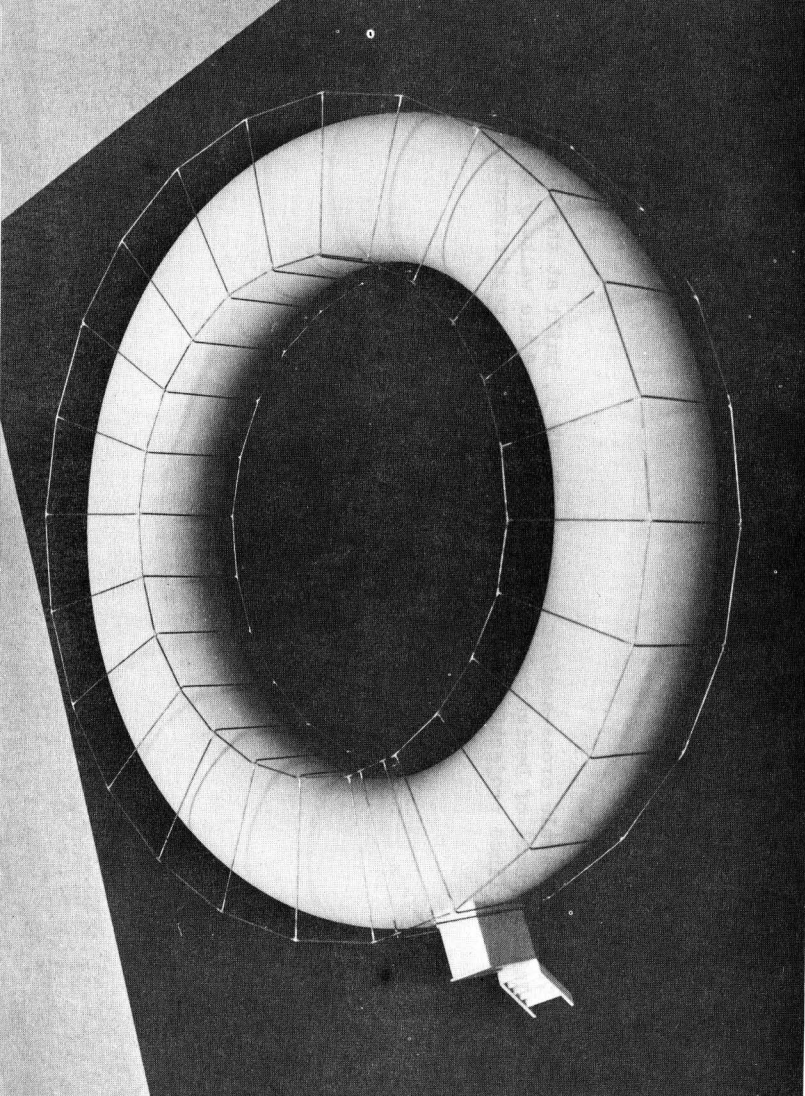

This air-liftable version of the TORUS information structure utilizes an enclosure and projection surface of non-rigid plastic supported by higher interior air pressure.

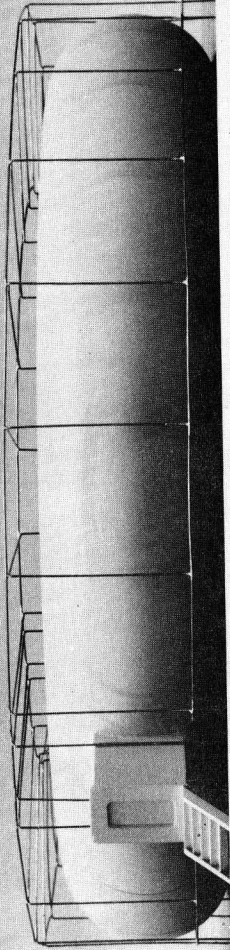

This air supported TORUS 2 is surrounded by a knockdown frame of aluminum tubing used for mounting the projectors. The entry airlock is at left.

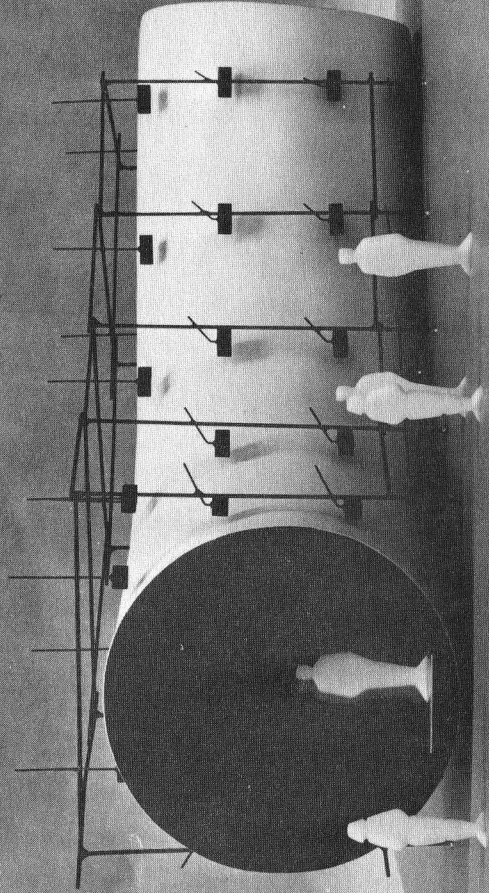

This detail model of TORUS 2 shows placement of projectors and the scale of the participant in relation to the circular cross section.

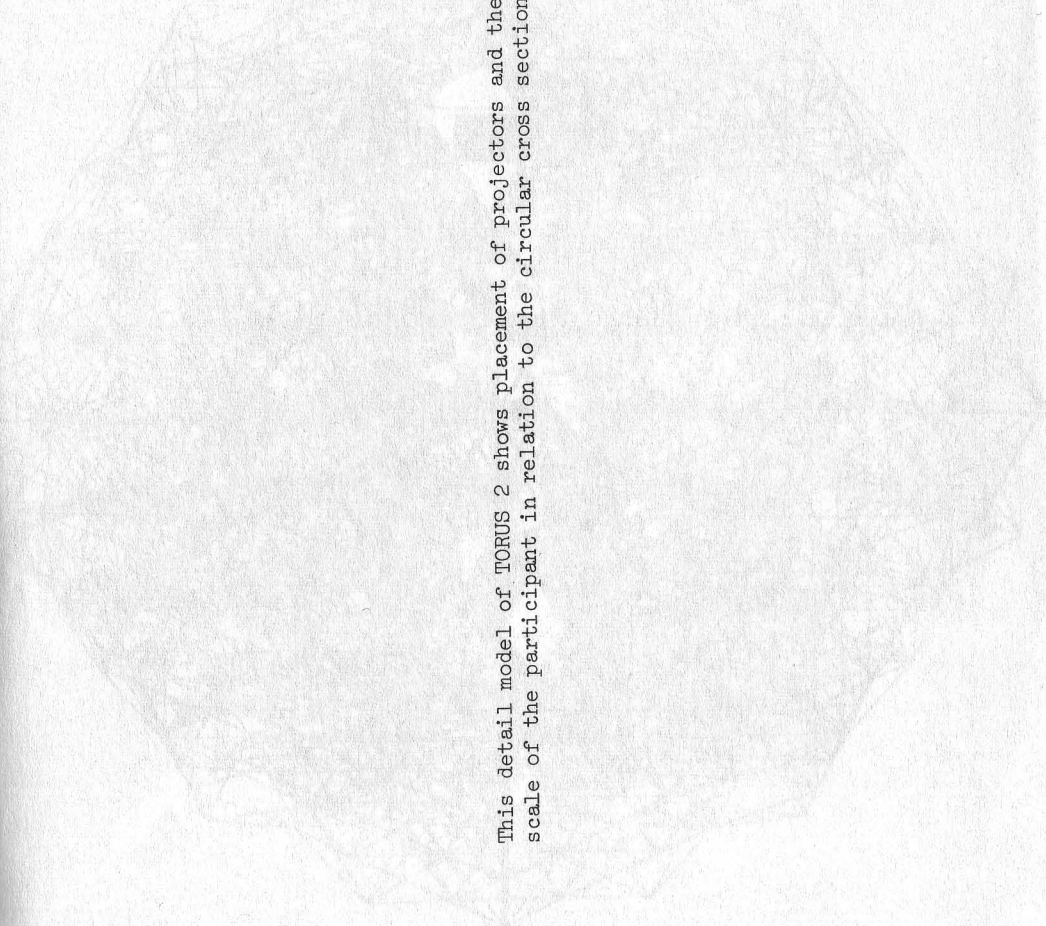

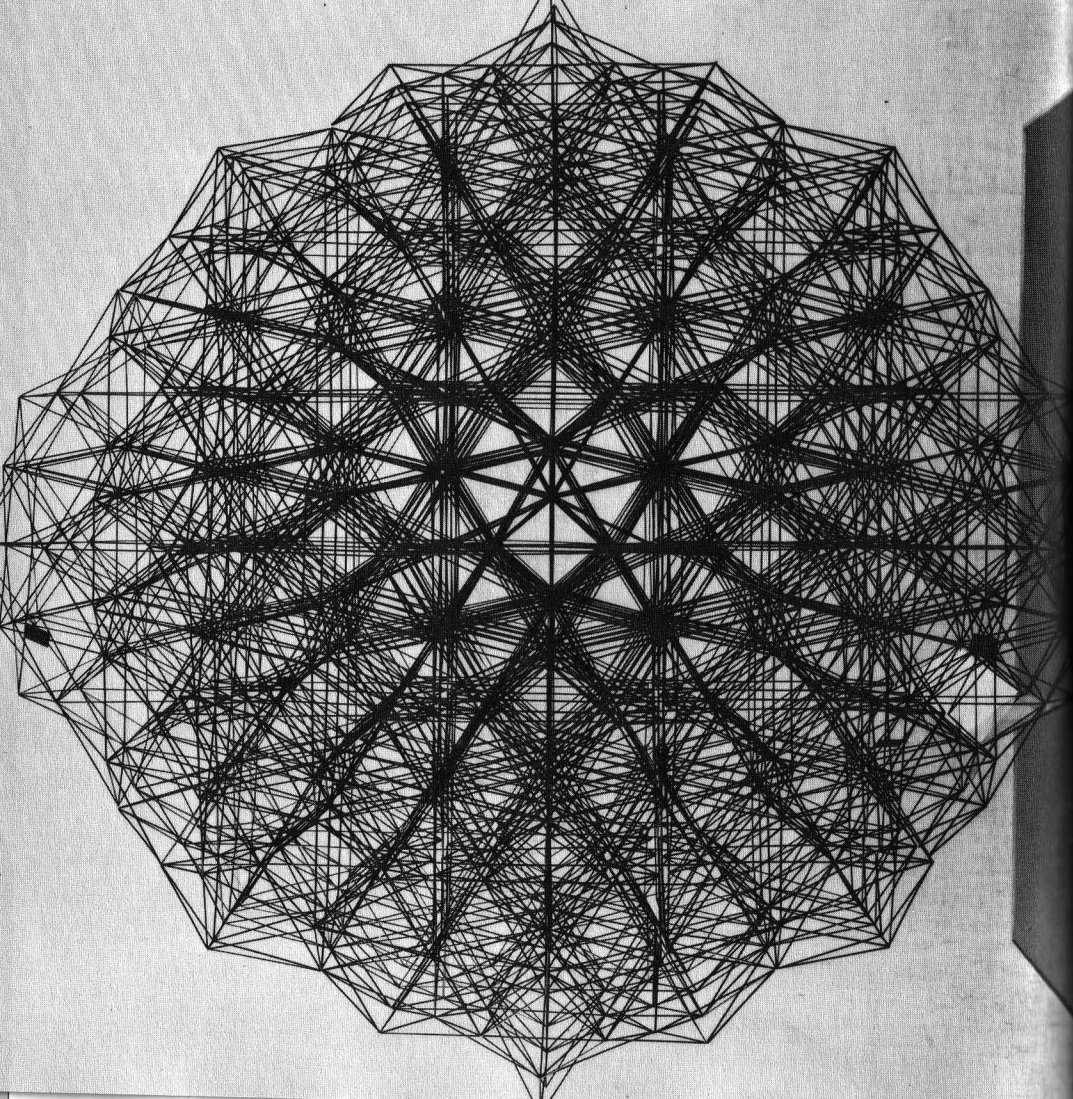

This information structure was conceived as the prime unit in a new kind of university to provide the major shared informational experience for the students. Generalist, total and comprehensive exposure was to precede any contact with teachers possessing specialized knowledge.

The complex was named SPACE UNIVERSITY.

KNOWLEDGE BOX

The KNOWLEDGE BOX was an isolation chamber or MATRIX in which a student could literally be surrounded with INFORMATION.

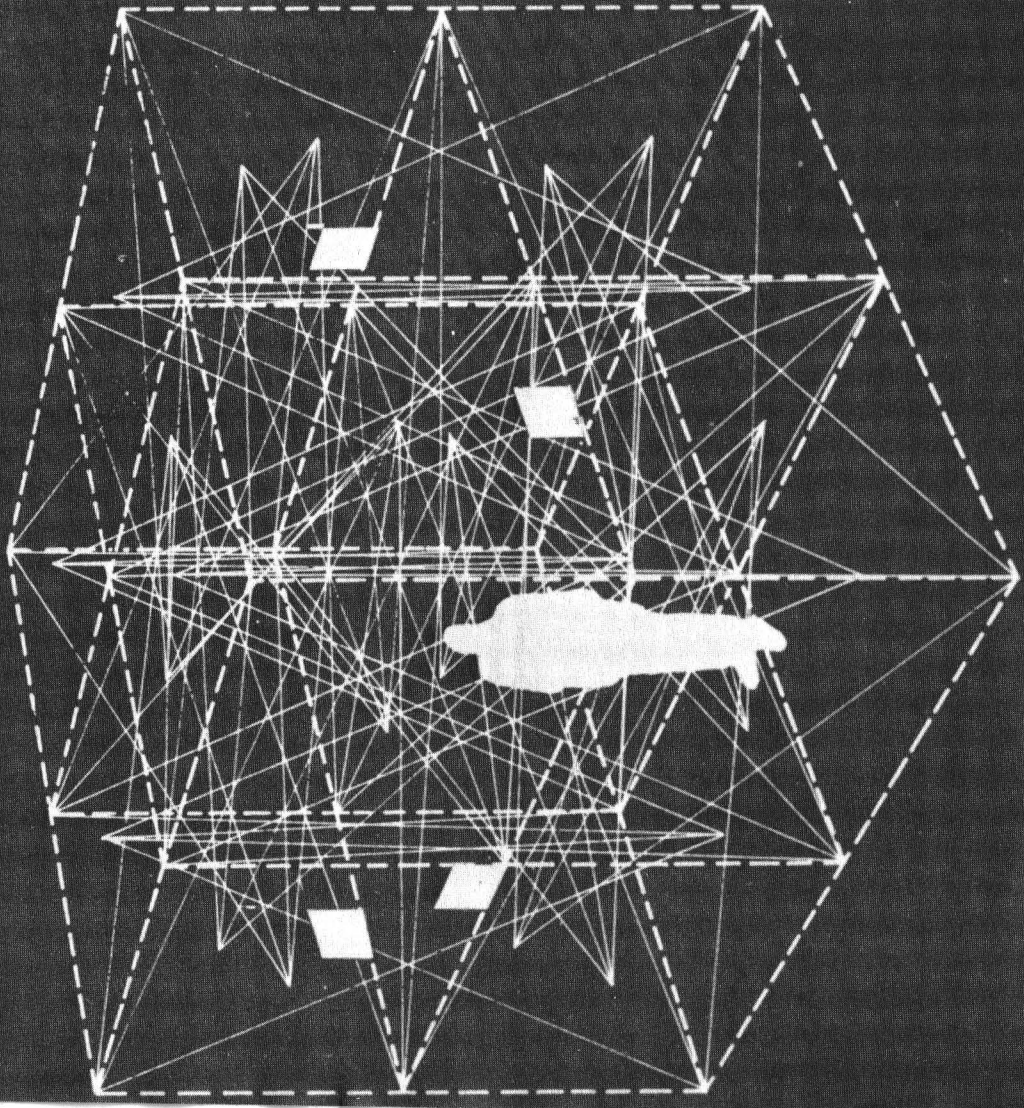

This projection diagram for the KNOWLEDGE BOX shows the four 6' projection modules on each of the six faces of the 12' chamber.

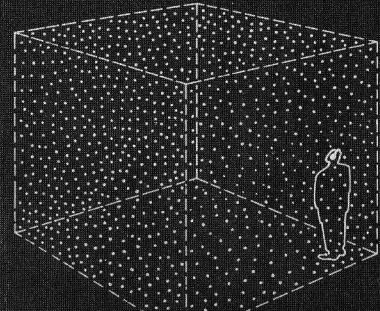
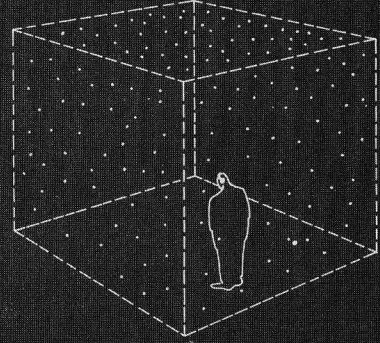
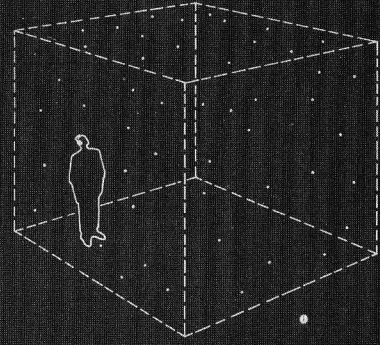

The KNOWLEDGE BOX is unique in the ability to render abstract concepts such as that of the geometric progression. The growing dot pattern is augmented by an audio track picked up by wireless earphones worn by each participant.



This PHOLAGE was one of the configurations used in a KNOWLEDGE BOX program. The MATRIX environment is challenging and dynamic, sharpening observation and generating participation and movement. I believe that this kind of structuring is a synthesis resulting in a life analog in a configurational sense. Our eternal problem has been to invent pattern concepts which have increasing fidelity when compared with our "percept of the world."



Interior photograph of the environment showing projection modules and the effects of scale change and juxtaposition.



Interior photograph of the environment showing one stage in a program on antropology and comparative culture.



The quality of movement and reactance which persons exhibited when having the matrix experience has opened other speculative areas. Changes in order and selection of program materials indexed to fluctuations in heart rate and blood pressure could be explored in a higher level example.

PROGRAM

We were eager to try one of the fascinating new modes offered by this mobile MATRIX. It was possible to operate it in an analog mode. That is, it could be used as a model representing, and equivalent to, an event or series of events. One of the students had worked out a two-dimensional translation which could be applied to a demographic model.

The model was constructed on the basis that the inside projection surface was earth surface with land and water areas observed so that they are seen in the normal relationship: North Pole at center of top cube face and South Pole at center of bottom face. Population was indicated by $\frac{1}{4}$ " diameter spots of light, each spot equivalent to 1000 men or menlike animals.

Of all components of this model, time was the most important. This was the quantity which would render the information experiential rather than literary. Even the greatest traditional communicators were weak on this point because there is no equivalency between the words, "six hundred thousand years," spoken in a lecture or written in a book, and the objective phenomena.

When information like this is put to you in the traditional manner, it is almost impossible to relate the symbol to the antecedent in a profound way. The result is that you don't really know it in your guts and your consciousness suffers from the fault.

We used scale time. One second of chamber time was considered equivalent to 1000 years of real time. The real time range was fixed at 600,000 years which scaled out to 10 minutes in chamber experience. Despite the scarcity of information through most of this time range, since the general view of population increase was the most important thing to communicate, we took the best guesses of historians, anthropologists, sociologists and demographers.

To give some sense of broad physical earth environment changes during the period of population increase, information about ice-cap formation at the poles was included. This provided an index and relating factor. The ice was projected in a dark violet gel, integrated with the appropriate slides, with area changing with time to match its advance and retreat in relation to total earth surface. The global map was not projected but the points of light representing men were located in terms of a 1 to 1 correlation between the globe and the corresponding area of the inside chamber surface.

Following an initial set of data translations which made clear these encoding equivalents, the chamber occupant became the participant in the previously inconceivable snail's pace change in human numbers. Human life appeared in scattered, hospitable areas, increasing and decreasing to the substantial rhythms of glaciation. The audio was wind, rain, thunder and the breaking of waves as the light spots followed the game and the sun in the quest for continuity.

Population increased almost imperceptibly, gaining momentum as the skills of the human animal developed in response to the challenge of the environment. Despite these gains, after 9½ minutes and 54 seconds (approximately 6000 real years and six seconds chamber time from today) domesticated animals lowered on the sound track and the people jumped in numbers in response to the technology of cultivation.

It was still dark and spotty in the earth analog and the situation didn't change much until 9 minutes 57.5 seconds (.5 seconds away from the program end) when the ear exploded with the noises of the industrial revolution. This change altered man's relationship to earth so that in the last .1 second the entire chamber lighted like a Christmas Tree with population equivalents. Their patterns delineated the continental land masses of the globe.

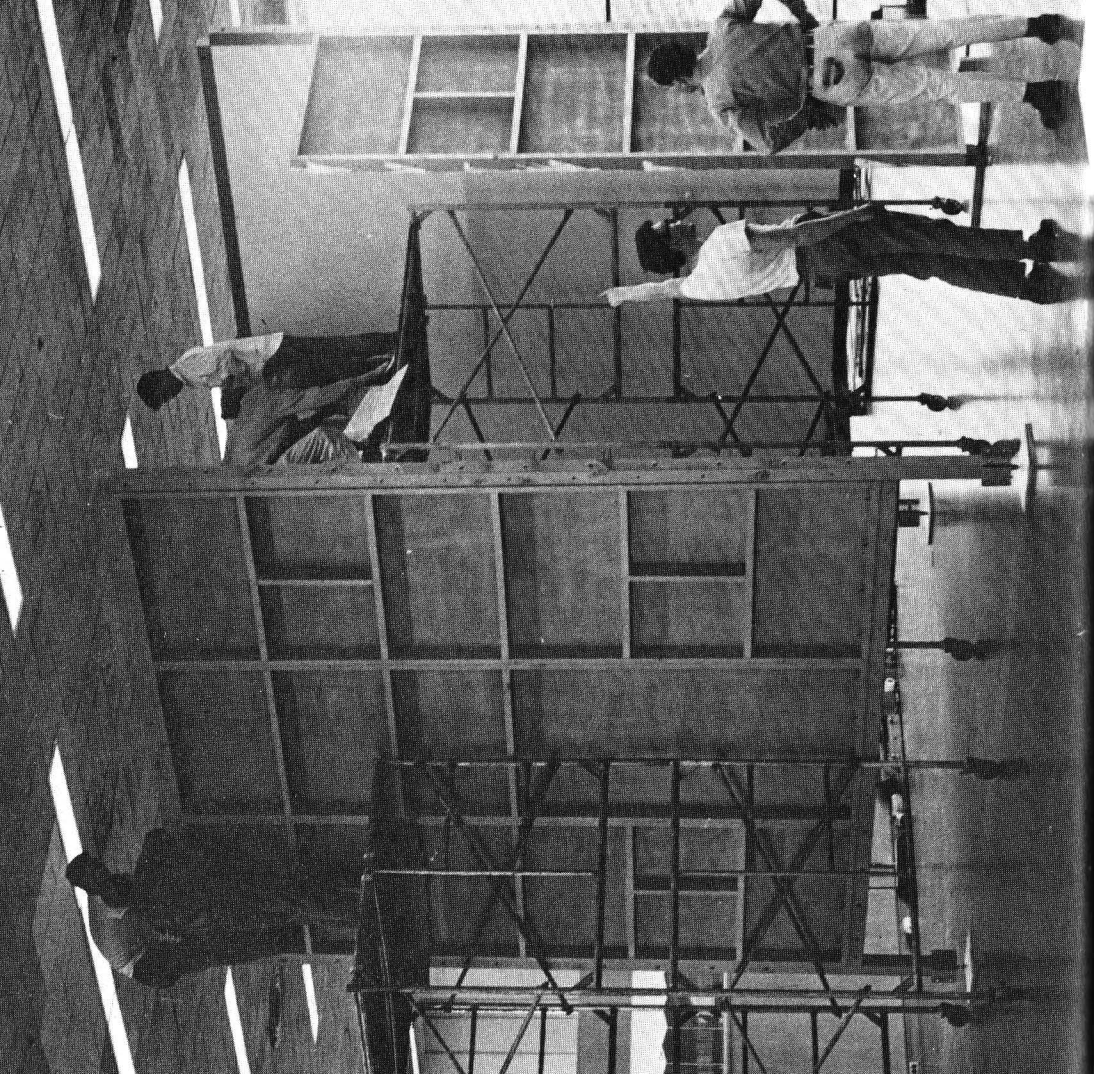

The KNOWLEDGE BOX was assembled in one day by the same students who did the fabrication of the parts.

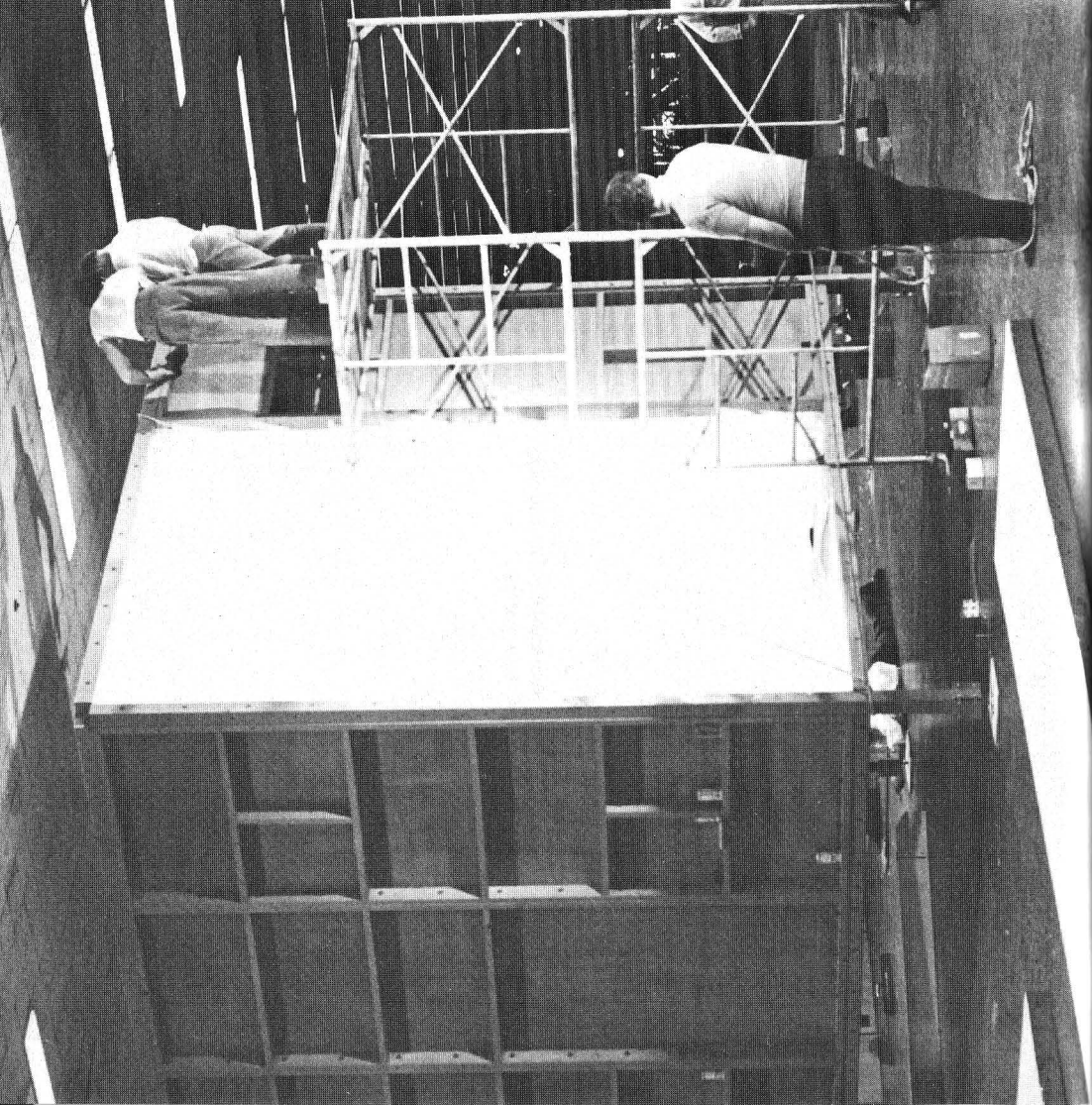

Simple bolted construction was used. Experiment is often impeded by notions from the old fashioned culture which suggest that only elaborate and over-complicated technology can produce new and useful ideas.

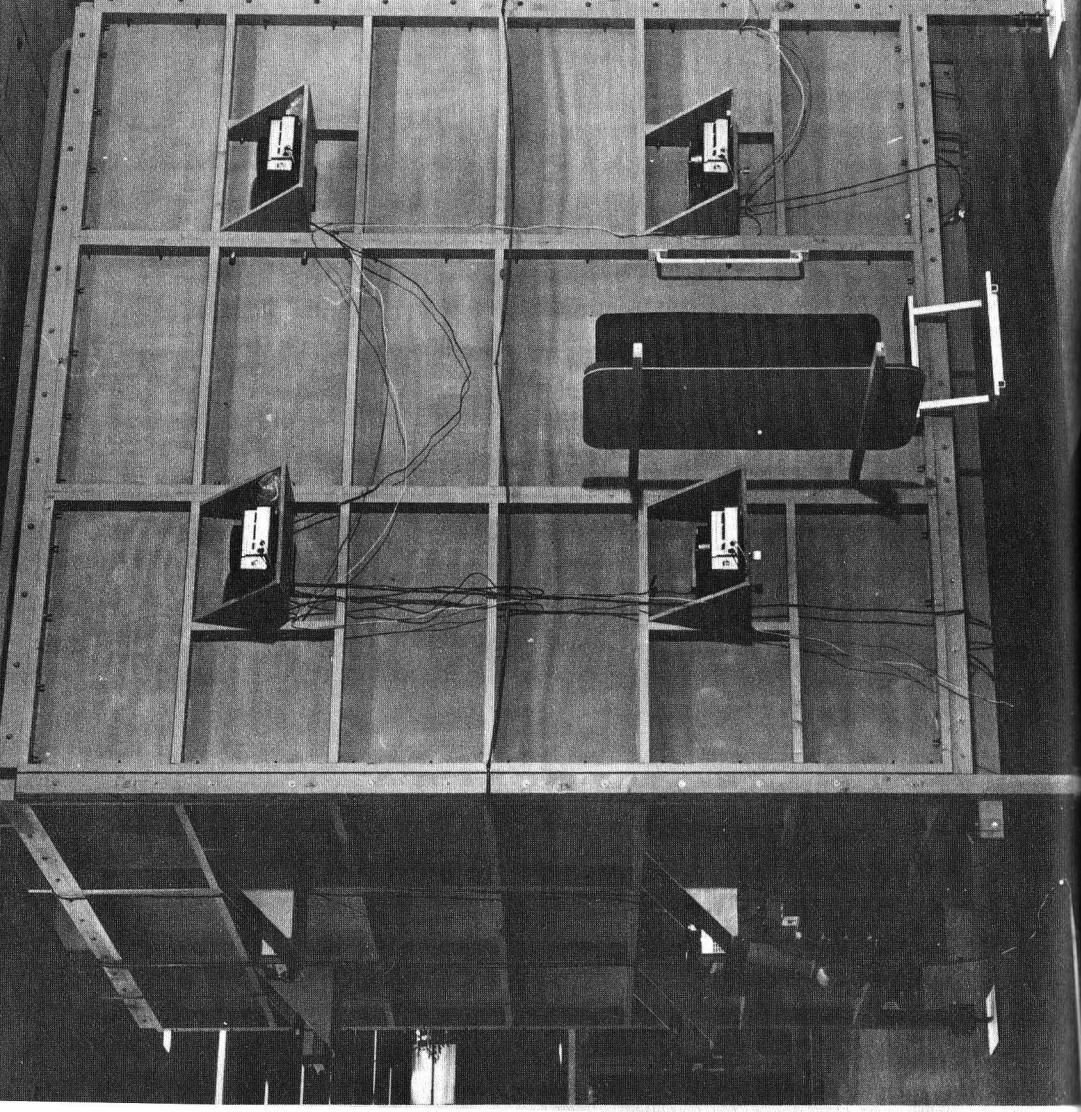

This photograph of the KNOWLEDGE BOX shows placement of projectors.

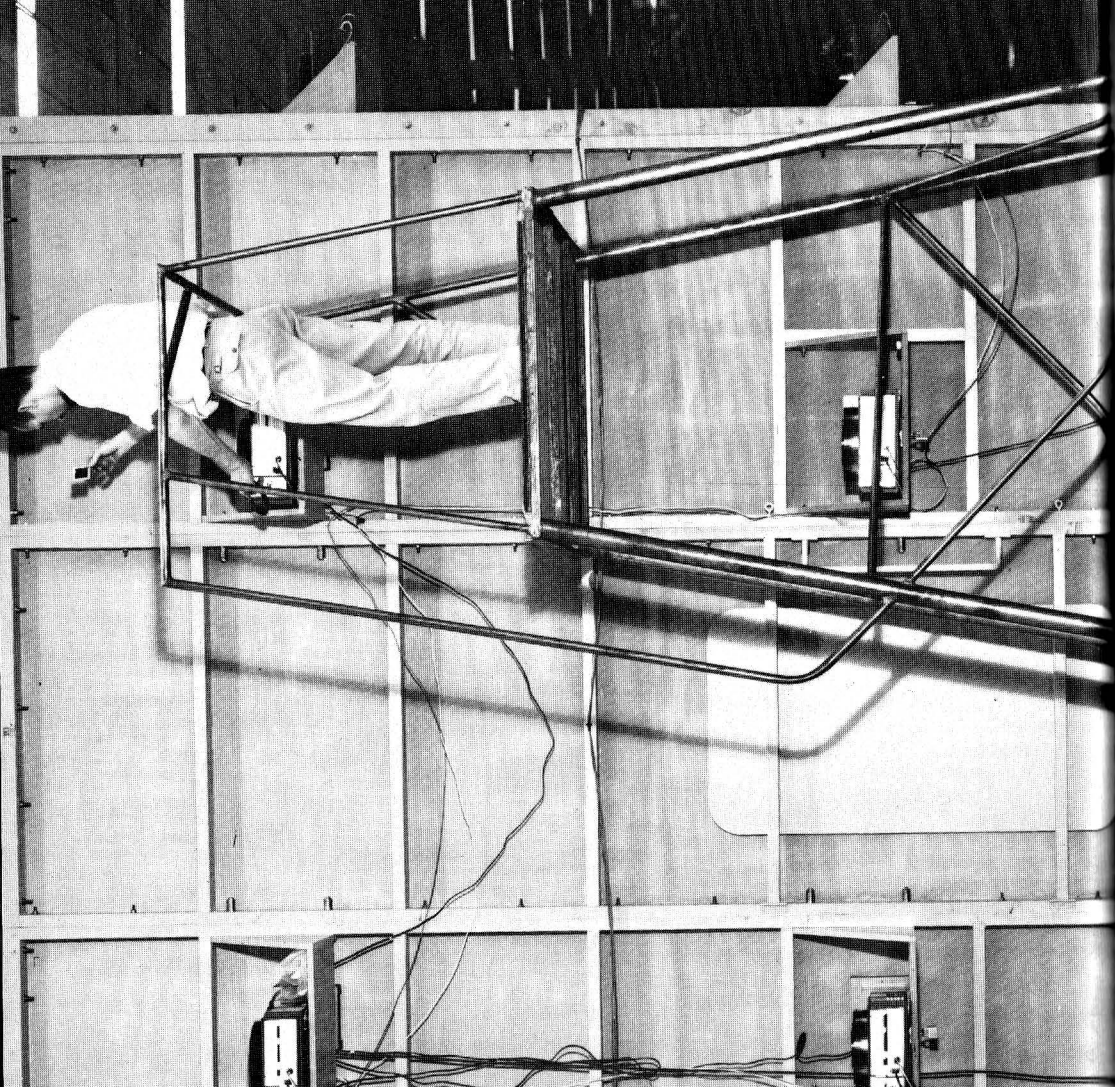

A special rolling scaffold was designed and fabricated to simplify the loading of projectors and changing of program material.

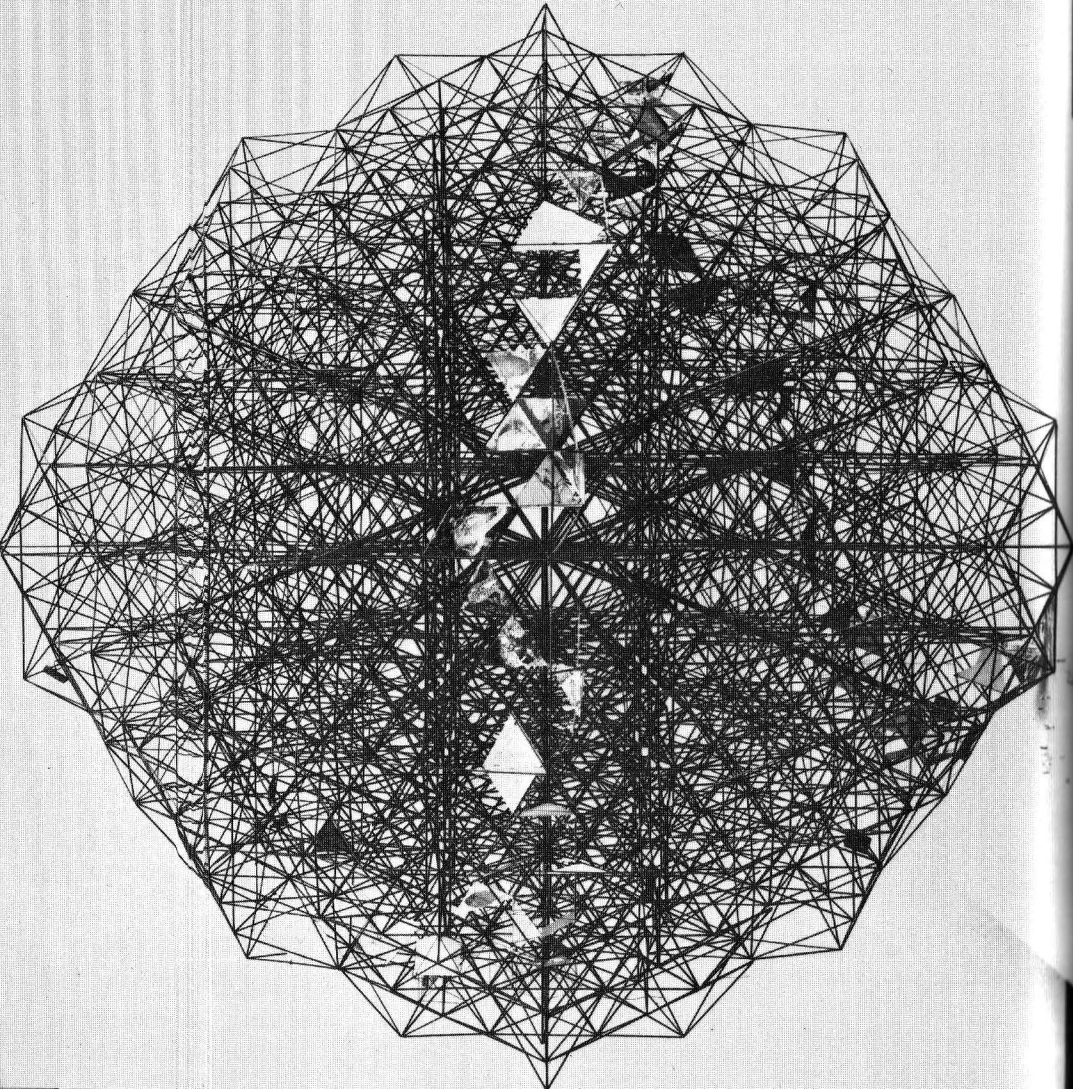

This expansible frame of tetrahedrons with an information path running through it like the Cretan labyrinth was designed at the Institute of Design in 1961. The scale was large enough to allow the participants to be mobile within it, each on a personal expedition of discovery through all our available information about the universe.

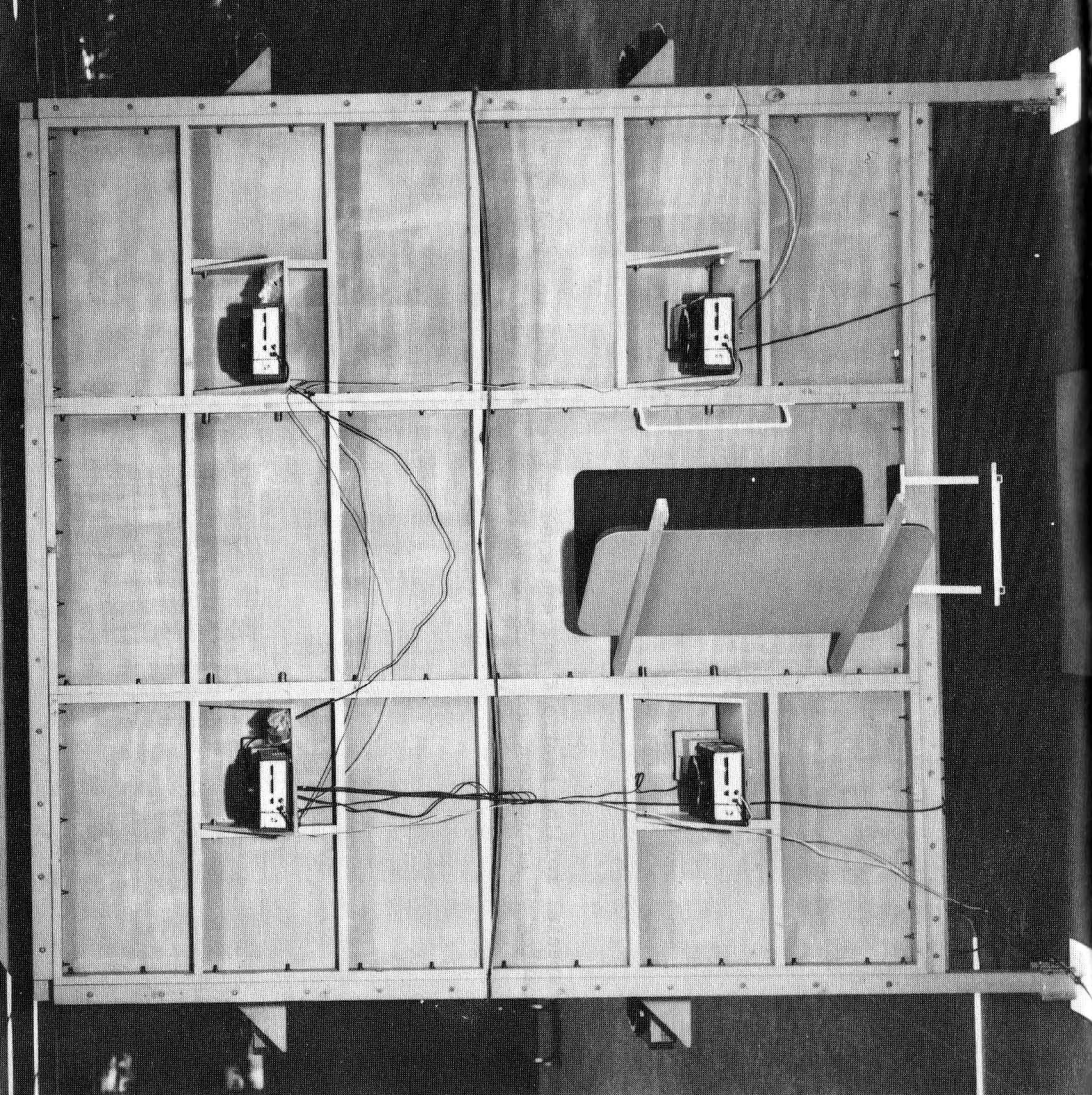

INFORMATION usually expressed in a literary fashion or abstractly has been rendered experiential and concrete by the MATRIX. This conversion to the concrete is important because our increasing use of the technology of abstraction reduces our ability to recognize the consequences of our actions.

Reference List

1. HOME IN A CUBE
2. MATRIX AT CRANBROOK
3. THE LIVING STRUCTURE
4. THE KNOWLEDGE BOX
5. THINK BOX
6. INSIDE THE KNOWLEDGE BOX
7. HOW TO BUILD THE SUPERCHAIR
8. THE BASIC PAD
9. LIVING STRUCTURES
10. LIVING STRUCTURES
11. HOW TO BUILD THE MICRODORM

Life 10/11/54
Industrial Design 3/58
N. Y. Herald Tribune 1/23/61
Life 9/14/62
Industrial Design 11/62
Toronto Star Weekly 12/29/62
Popular Science Monthly 3/68
Look 5/14/68
House Beautiful 6/68
N. Y. Times 1/3/69
Popular Science Monthly 3/69

Carole Rabito correlated all the material used in this book.
She also designed the cover.

It was the finest collaboration I can remember.



This book is dedicated to my father, the first ecologist I ever met.

Ken Isaacs was born in Illinois. His experience as a farm boy during the depression generated his deep interest in the ecology of the human animal. The wide sweep of the plains and what he has termed "extremely penetrating and inventive attitudes" on the part of his parents coupled to produce this interest.

As head of the design department at Cranbrook Academy of Art he had the opportunity to test and build environmental education units which he had invented some years before. This educational work continued with terms as visiting lecturer at Rhode Island School of Design, Pratt Institute, the University of Cincinnati, and Illinois Institute of Technology. His ideas for replacing the conventional classroom with controlled low-distraction environments specifically constructed for high-range multiple information input have attracted wide attention from persons in the educational field and communication specialists.

Isaacs' work in artifactual invention has also generated international interest. The "living structure" which he has also developed has enjoyed wide publication as the first significant change in the idea of furniture in the last 1000 years. One eminent critic called it "universal living equipment."

Ken Isaacs is a survivalist and his work is about the survival of all people.